

PROJECT AQUARIUS

(Special access intelligence revealed from the “Dark Side of the Moon”)



By: Michael Schratt September 2010

SPECIAL NOTE: Anywhere in this article that the following icon appears (*), the disclaimer below applies.

-----DISCLAIMER-----

(The above sketch or computer generated illustration above does not conform 100% to Drs. Dan and Marci's testimony or descriptions, and should be considered strictly as a visual aid specifically designed to give the general public an overall idea of what this area of the facility actually looked like.)

Of all the cases of human contact with extraterrestrial intelligence, one case in particular stands out as being the most significant, with potentially bombshell implications. This is the account of Dan Burisch (PhD Microbiologist), and his contact with an extraterrestrial known as J-Rod at Area S-4 (12 miles south of Area 51). Dan Burisch was born on February 2nd, 1964 in Lynwood CA. Dan's mother (Doreen), worked as a Telex operator, while Dan's father worked for the Purex company. Early on, Dan showed an intense interest in optical instruments, and received his first microscope at the age of five as a Christmas present. Eventually, Dan's enthusiasm for the science of histology caught the attention of Dr. James Reynolds from Long Beach Memorial hospital, who would become his tutor after being referred to by his Mother Doreen.

At the request of Dr. Reynolds, Doreen was encouraged to purchase for Dan, a used professional grade microscope from Dr. De Haas (professor at USC). Dr. De Haas was on the board of the Los Angeles Microscopical Society (LAMS), and arranged for Dan to be the youngest ever member to be elected to the organization. Shortly after joining LAMS, Dan's parents moved to Las Vegas, but it was decided that his studies were vitally important for his career, so arrangements were made to fly Dan from Las Vegas on the weekends to attend the monthly meetings. In 1985 and 1986, Dan was conferred separate Bachelor degrees in Biological Sciences and Psychology by the University of Nevada at Las Vegas, and congratulatory letters from Senators and Congressmen, and others which are on file, and available for review through OpenMinds.





In March of 1986, Dan was approached at UNLV by members of the so called “Secret Government” or “SG”. Three men, two in military uniforms, and one in semi-military clothing approached Dan, and offered him a job working on a TOP SECRET program where his talents and skills could be exercised to the fullest extent. He was promised access to the latest scientific laboratory equipment, and was assured that budgetary funding would never be an issue.

Several contacts occurred, and afterwards contact ceased near the end of 1986. By 1987, Dan had assumed that they had cancelled his participation in the program. By this time, Dan decided to explore a possible future as a priest with the Roman Catholic Church. He underwent psychological and other assessments, and finding him to be normal, they accepted him for seminary training at St. Patrick’s School of Theology in Menlo Park CA.



After leaving Seminary School in 1987, and with no further contact by the government, Dan began work as a parole and probation officer for the state of Nevada. At this point, members of the Secret Government again contacted Dan, and decided that his current place of employment would serve as an ideal “cover” for classified assignments which would be directed to him. By 1989, after Dan had been promoted to the court services unit after single handedly capturing a bank robber at gun-point in downtown Las Vegas, tissue samples would be sent directly to Dan’s office at the Parole and Probation department’s Phoenix building. From there, Dan would

take the samples to another location and examine them. Next, he would write up a detailed technical analysis, which would then be returned by him to the Phoenix building. The messenger would then be notified, and drop by to pick up the original slides and technical analysis.

During his employment with the probation department, Dr. Edward Teller (father of the H-Bomb), took in interest in Dan's work, and arranged for him to attend classes at the State University of New York, Stony Brook (SUNYSB).



Dr. Dan Burisch



Dr. Edward Teller

Dan was flown to and from New York via both a specially assigned military aircraft, and in a few cases commercial transport. In each case, he had two military escort personnel assigned to him. At SUNYSB, he was assigned to a special advisor who was an expert in glycoprotein research who also sent him modules to Las Vegas NV for him to study and arrange for proctored examinations in Las Vegas. By the end of 1989, he had completed a dissertation and defense for his doctorate in cellular biology. That, together with his work at Parole and Probation caused him to become bedridden for two months. In January of 1990, after recovering from exhaustion he was able to return to work at Parole and Probation. Soon thereafter, he met his future wife Deborah K. Burisch. Miss Burisch met Dr. Dan as a consequence from her own legal troubles. In the meantime, Dr. Dan's doctoral certificate from SUNYSB arrived at his parent's apartment (affidavit on file, under penalty of perjury by Doreen Crain, Dr. Dan's mother, stating that she received it and removed it from its mailing tube, whereupon Dr. Dan's father framed it and placed it on the wall of the apartment).

Dan became interested in Miss Burisch, and as he decided to engage a relationship with her, he decided to depart from his employment at Parole and Probation. Not long thereafter, Dr. Dan and Miss Burisch were married, and Miss Burisch decided to remove Dr. Dan's SUNYSB certificate from his parent's wall (affidavit on file under penalty of perjury by Deberah K. Burisch admitting that she took his Ph. D. certificate and would not return it to him). Due to Ms. Burisch's refusal to return the certificate, and save a probable photograph of her with that certificate, on file, it appears that the original certificate is lost to history. Dr. Dan's first wife has admitted to being a sworn agent of the secret government (in the previously mentioned affidavit) and was assigned to monitor Dan's activities. By 1998, Marcia McDowell using the pseudonym BJ Wolf published the book "Eagles Disobey, The case for Inca City Mars". Dan was listed as a coauthor, and supplied many images for the book. These images included potential artificial structures on Mars. However, members of the "Black World" were displeased with this disclosure of information, and proceeded to expunge Dan's educational

background, at two locations. Records of his Bachelor of Science in Biological Sciences were removed at the University of Nevada at Las Vegas, while another team erased evidence of his P.h.D. at SUNYSB. Prior to the erasure of the P.h.D. at SUNYSB, a coworker of Dr. Dan's, in a cover job (subsequent to his first "cover job" at Parole and Probation) called SUNYSB, and received confirmation of Dr. Dan's P.h.D. at that institution (affidavit on file, sworn under penalty of perjury, Robert Byrd). Evidence suggesting transcript tampering from UNLV is on file with OpenMinds. Additionally, original photographs and the original audio tape of Dr. Dan being conferred his Bachelor of Science in Biological Sciences by UNLV have been obtained, substantiating his account. Since that date, both Dan and Marci have been conferred other doctorates, the legal certificates for which are on file with OpenMinds in their vault. Dan's work on classified "black" programs began in the 1990-1991 time period. Concurrently, he was deployed in Operation Desert Storm as a defense bio-warfare expert in black ops operations. He refuses to discuss much about his role in bio defense.



By 1994, Dan received and accepted an offer to work on a TOP SECRET program known as Project Aquarius, located at an underground facility known as Pappoose Lake facility (S-4), (aka "The Dark Side of the Moon"), located 12 miles south of Area 51 in Nevada.

FEDERAL LANDS IN SOUTHERN NEVADA

Land use:



Legend:



Location:



Location of main map

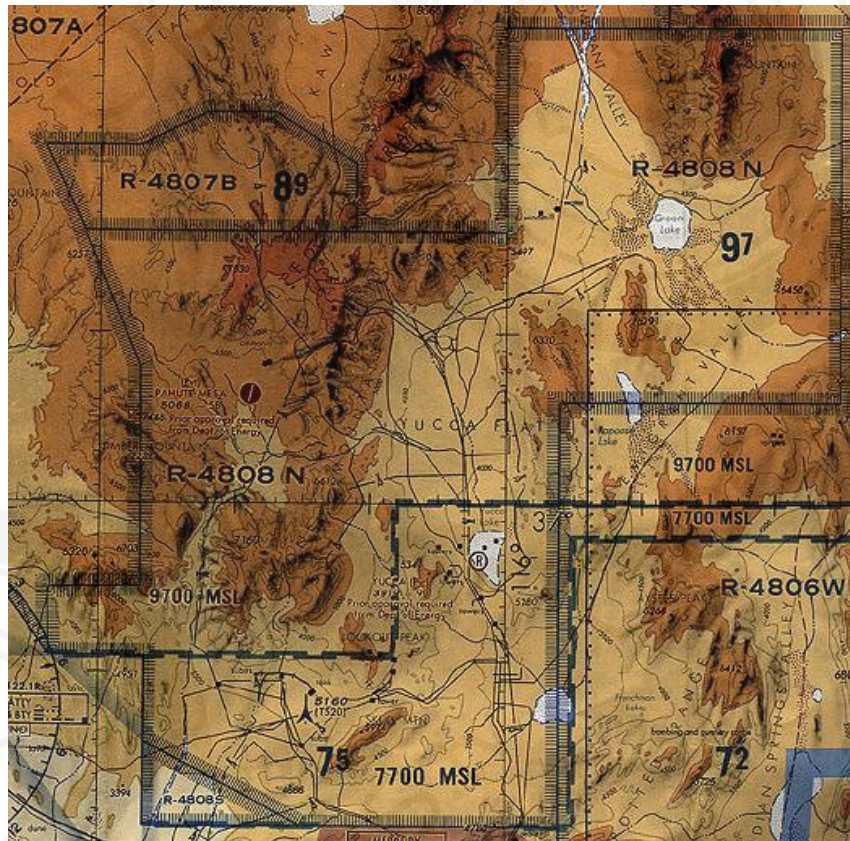
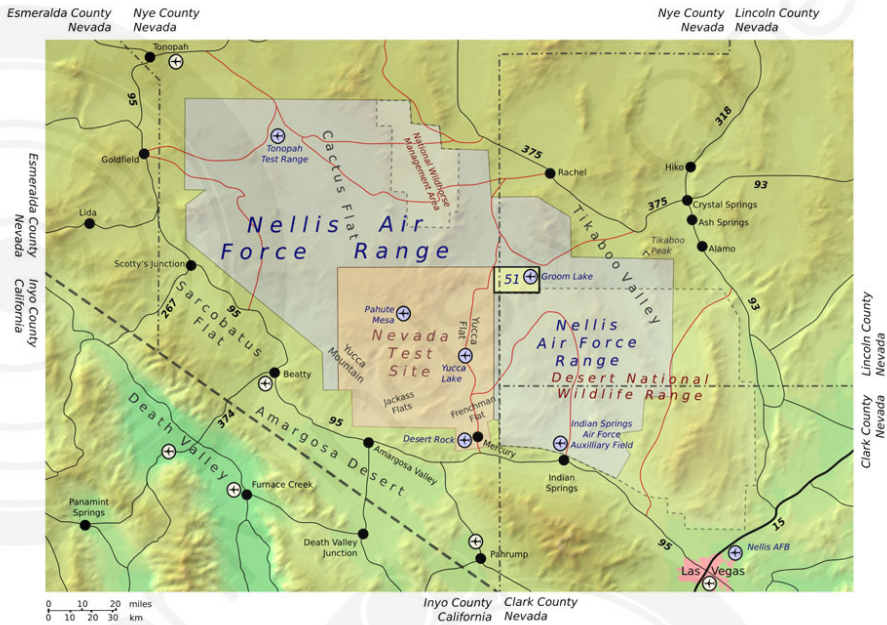

Security measures at the facility were very oppressive. This included armed guards, optical scans, voice print identification, showering, weighing, shaving, and decontamination. Dan was told he had been commissioned by the department of the Navy, and was given a secret "Q" clearance. At times he was assigned to work under the direction of the prestigious Naval Research Laboratory, and the Defense Intelligence Agency. These assignments were designated on official documents to legitimize his presence while working for a group called Majestic.



It was here at S-4, that Dan would come into contact with physical evidence that truly challenged his belief system. He learned that the U.S. military was in possession of hardware not originating from this planet. This included physical structured vehicles of extraterrestrial origin, and their occupants. He learned that the United States Government was working with extraterrestrial “visitors” for decades, and that many technological advancements directly associated with the field of military aerospace, were actually made through a “reverse engineering” program beginning in the 1940’s. Dan described the facility as having five working floors, with the last floor accessible by only one elevator.



Dan was transported from McCarran International Airport to Area 51 via “Janet” 737-200 airliner. The staging point for pick-up and drop off is the EG&G building across from the main terminal. These aircraft feature a painted white exterior, with a single red stripe running along both sides of the fuselage.



During the short Janet flight to Area 51, no talking was allowed between personnel that Dan was allied with. Dan described most of the interior cabins as being “slate grey” in color. When entering the aircraft, Dan was instructed to sit near the aft end of the cabin, and then a drape was pulled, thereby separating his section with that of the rest of the cabin. Seating arrangements are carefully chosen so that passengers are “quarantined” from various personnel who may be working on various different programs on the base. On approach to landing, Dan remembered hearing the call-sign “Pyramid Pyramid Pyramid”. This may have been the authorization clearance from Groom Lake air traffic control, allowing jets to prepare for final approach to Area 51.

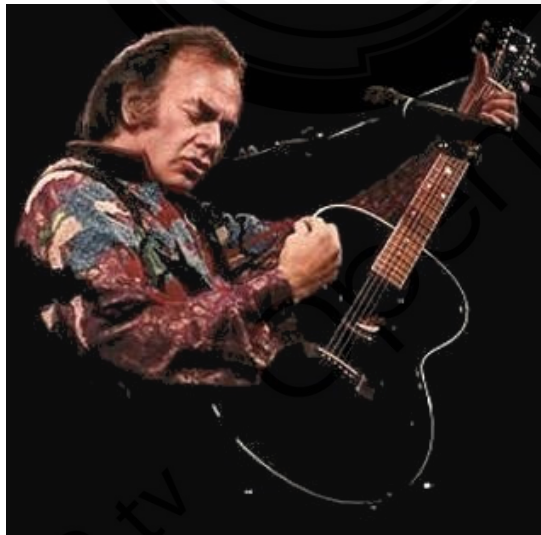
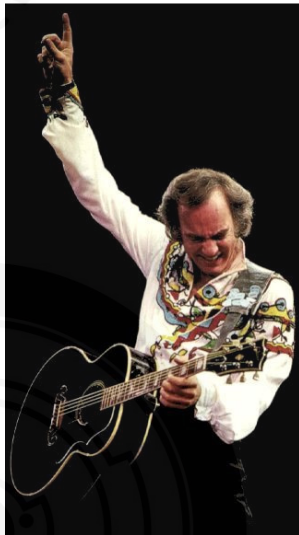

On the way to Area 51, Dan recalled that the pilot played a very interesting song over the public address system. This song was none other than Neil Diamond’s “Coming To America”. Dan remarked that this song would be played over and over during the flight in his section. In its original interpretation, the song symbolizes immigrants from around the world who are “Coming to America” in search of a better life. However, taking into consideration what goes on secretly at Area S-4, the song takes on an entirely new meaning. Was the purpose of playing this song on-board the Janet 737-200 an encrypted symbolic reference to extraterrestrial races who are “coming To America”, specifically Area S-4?



Transportation from Area 51 to Area S4 was by either standard issue blue colored Air Force bus, U.S. Army Blackhawk helicopter, or Soviet Mi-24 Hind helicopter.

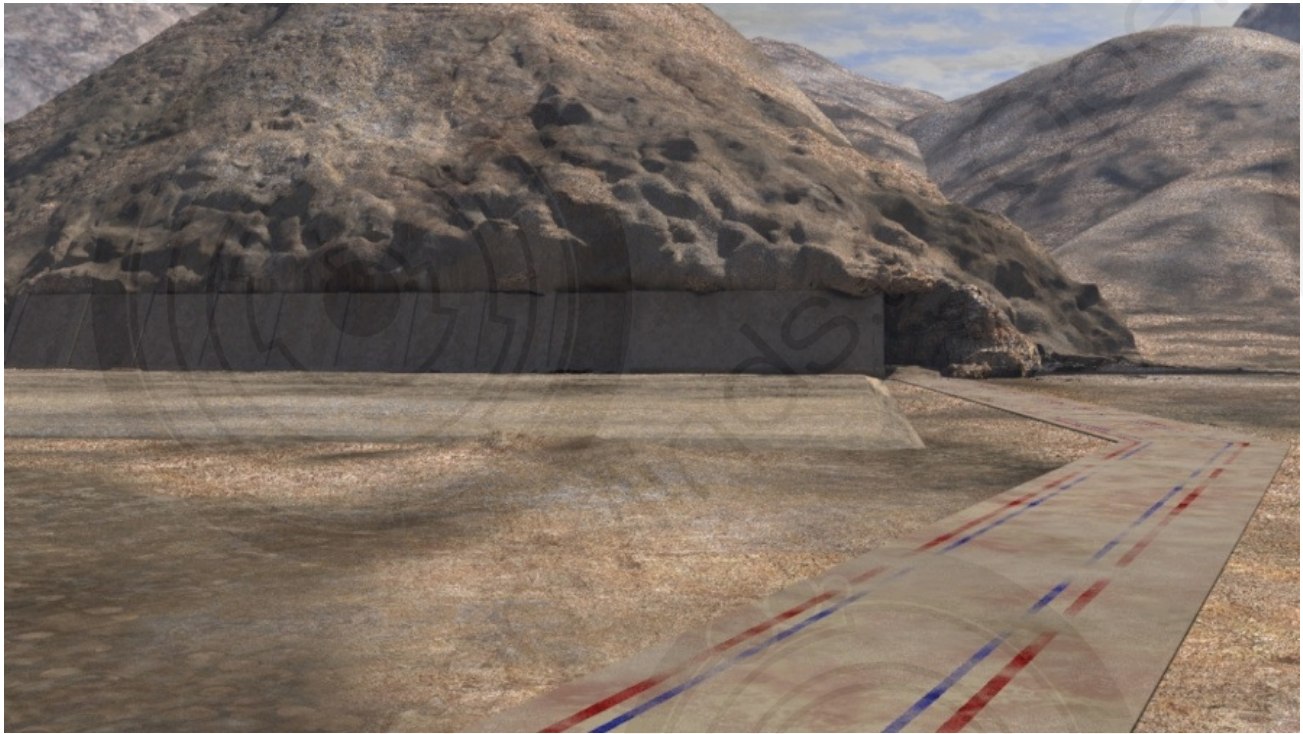

Exterior view of the S4 facility showing the nine hangar bays, and painted walkway. *



View depicting entry door to the S4 facility.*



View depicting entry door to the S4 facility.* (Note: this door actually utilizes a double sliding configuration, see illustration below)

*FROM THE OUTSIDE,
WITH THE DOOR
CLOSED.*

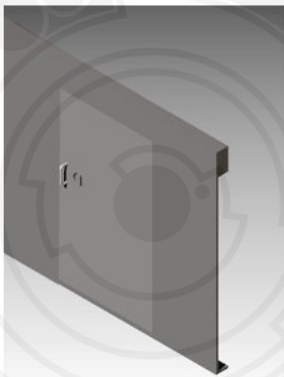

*FROM THE OUTSIDE,
WITH THE DOOR
PARTIALLY OPEN.*



*FROM THE INSIDE,
WITH THE OUTER
DOOR PARTIALLY
OPEN.*



Updated view Area S-4 entry door detail.

The S4 facility has nine hangar bays which are built into the side of the Papoose mountain range at an angle of 60 degrees. The exterior texture of the bay doors were specifically designed to blend in with the surrounding background. A small tarmac is located immediately in front of the hangar bays to facilitate the removal of the different craft. A unique walkway consisting of parallel blue and red lines leads directly to the front entrance. Dan was told to stay within the blue lines, and never to break the boundaries of the exterior red lines. Security guards along this oppressive walkway had “shoot to kill” orders to neutralize anyone who breached the red lines.

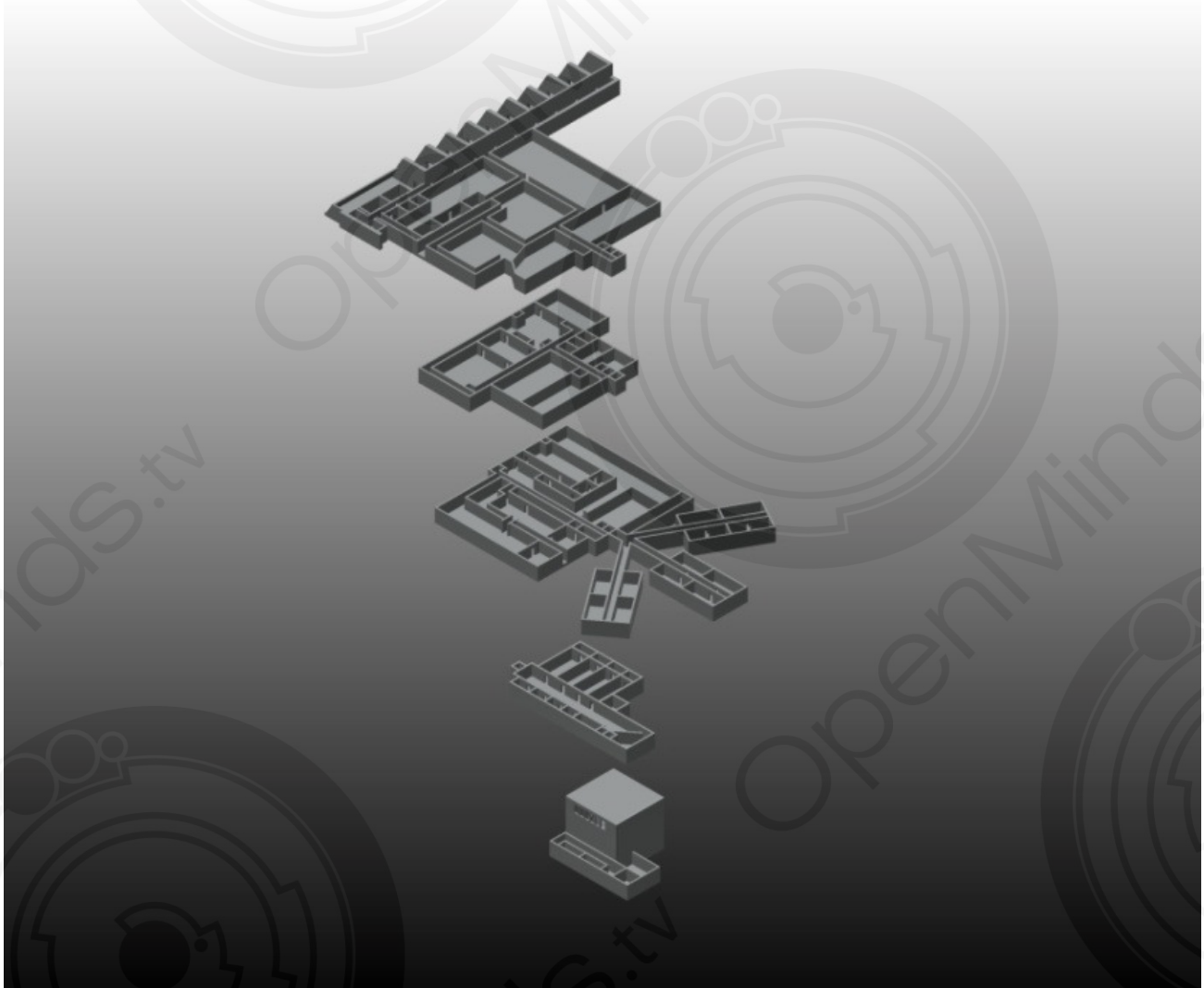

AREA S-4 SUB FLOOR LAYOUT

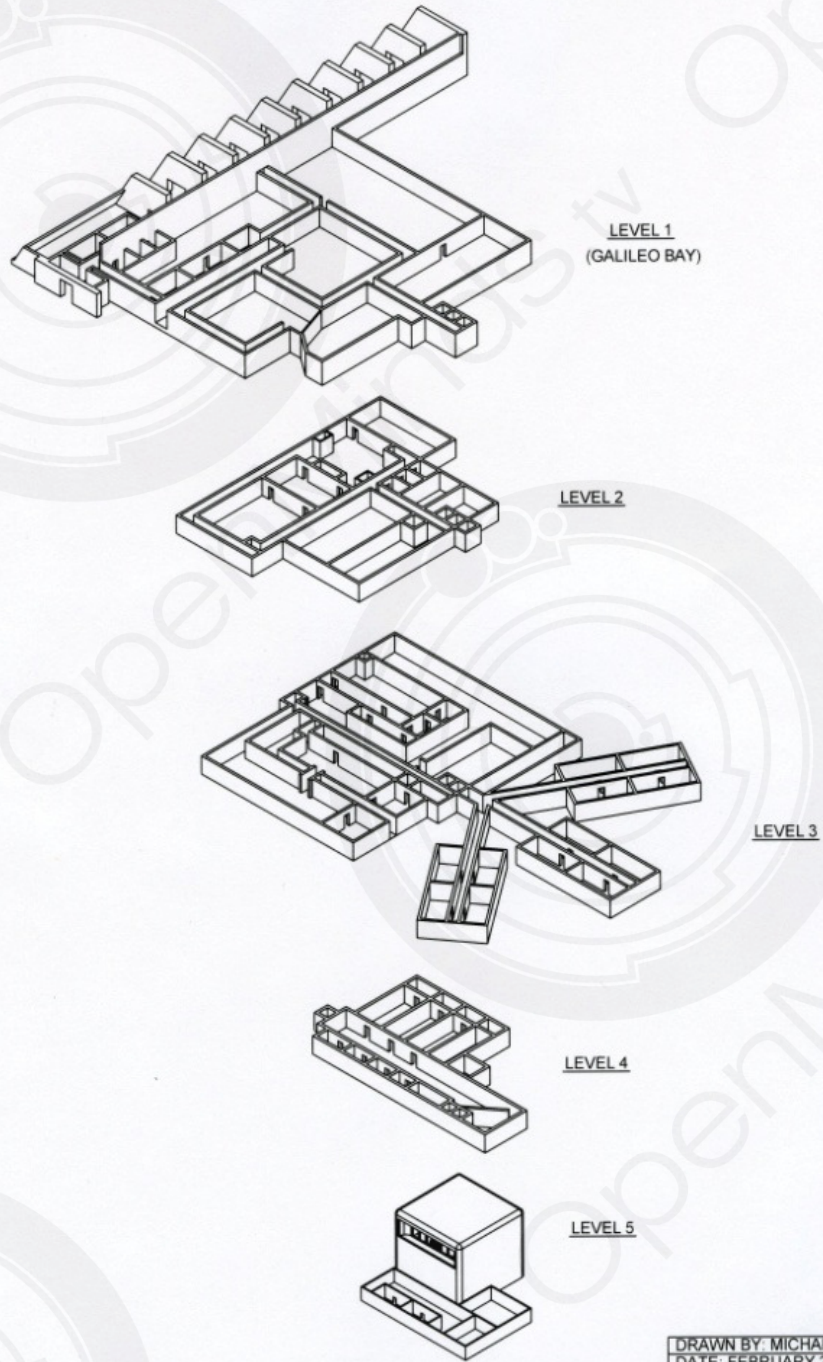

Exploded view of Area S-4 showings levels 1-5 as described by Drs. Dan Burisch and Marcia McDowell. The facility was originally designed as a biological weapons laboratory in the early 1950's. After arriving at Area 51, Dan would either be driven by a bus or flown by helicopter to Area S-4.

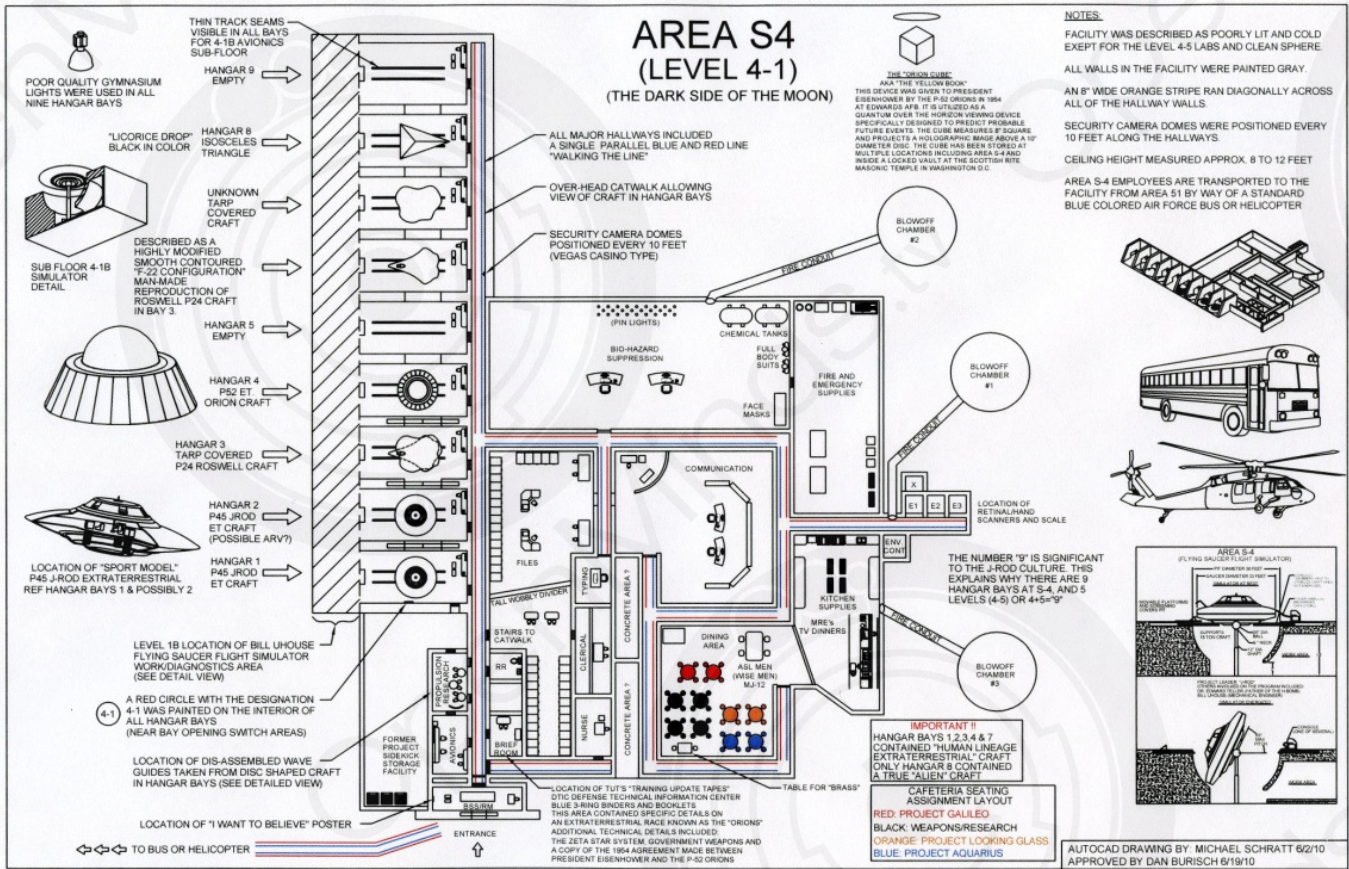

Level 1 housed fire control equipment, a dining facility, communications, security/surveillance, an avionics laboratory, and the archives or files department. Provisions for a propulsion research laboratory are also housed on the first floor of Area S-4. The dining area seats consisted of round tables with four attached round seats. The cafeteria seating arrangement was broken down specific projects which included: Project Galileo, weapons research, Project Looking Glass, and Project Aquarius (see level 4-1 floor layout drawing). Note: special members of MJ-12 had their own designated table in the cafeteria. The interior of all nine hangar bays included a red circle which contained the designation 4-1 in red text.

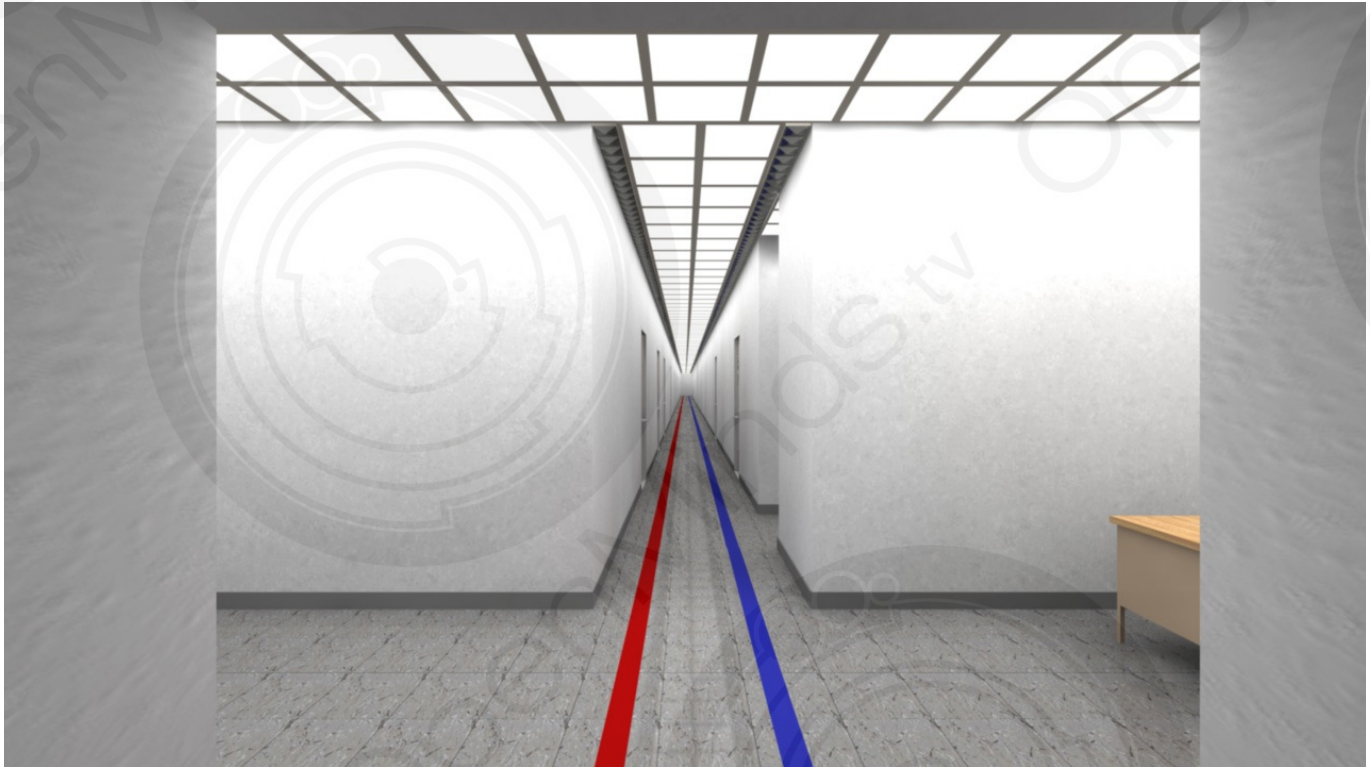

View looking down the main hallway immediately after opening the door.



View looking down the main hallway on Level 1 of S4



Left side view of main entrance showing "I want to believe" poster



View looking to the right showing badge area.

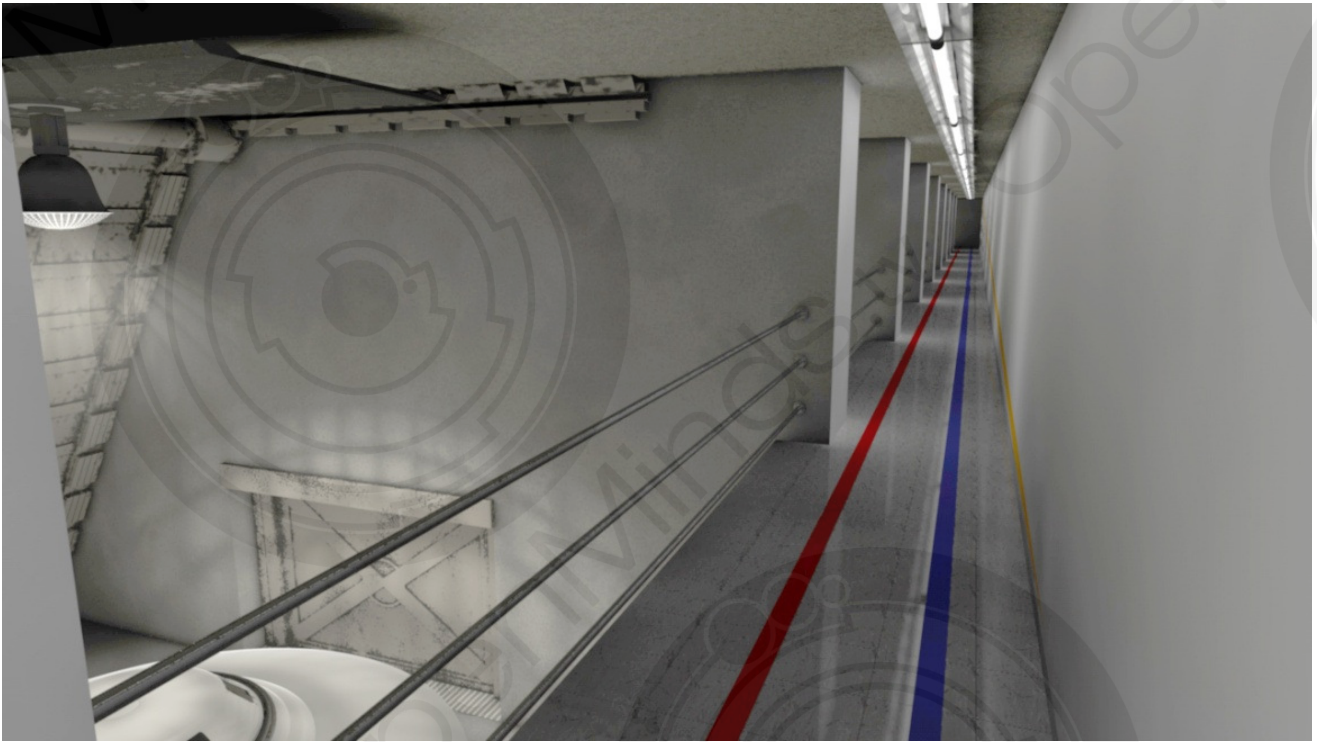

View of upper catwalk looking down the length of the nine hangar bays.*

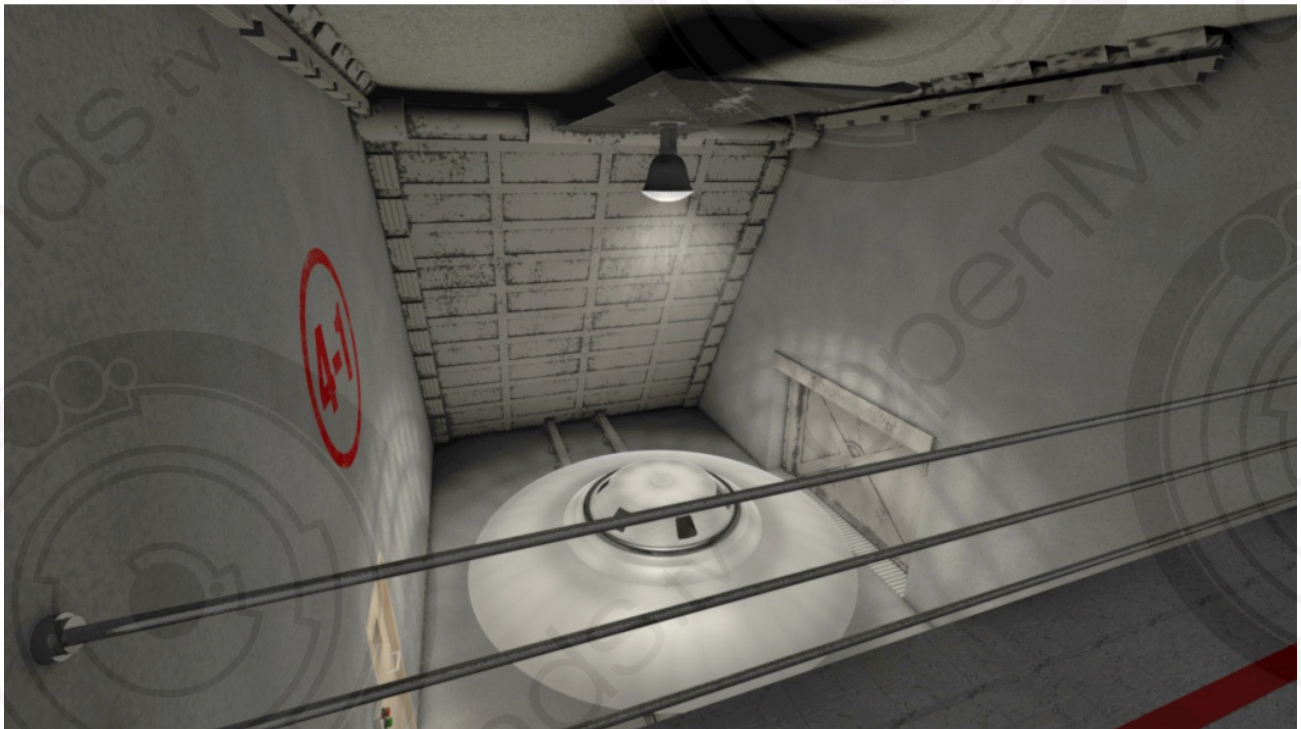

View of P45 J-Rod craft in hangar bay 1 from the perspective of the catwalk showing “sport model” (identical craft also in hangar bay 2). *

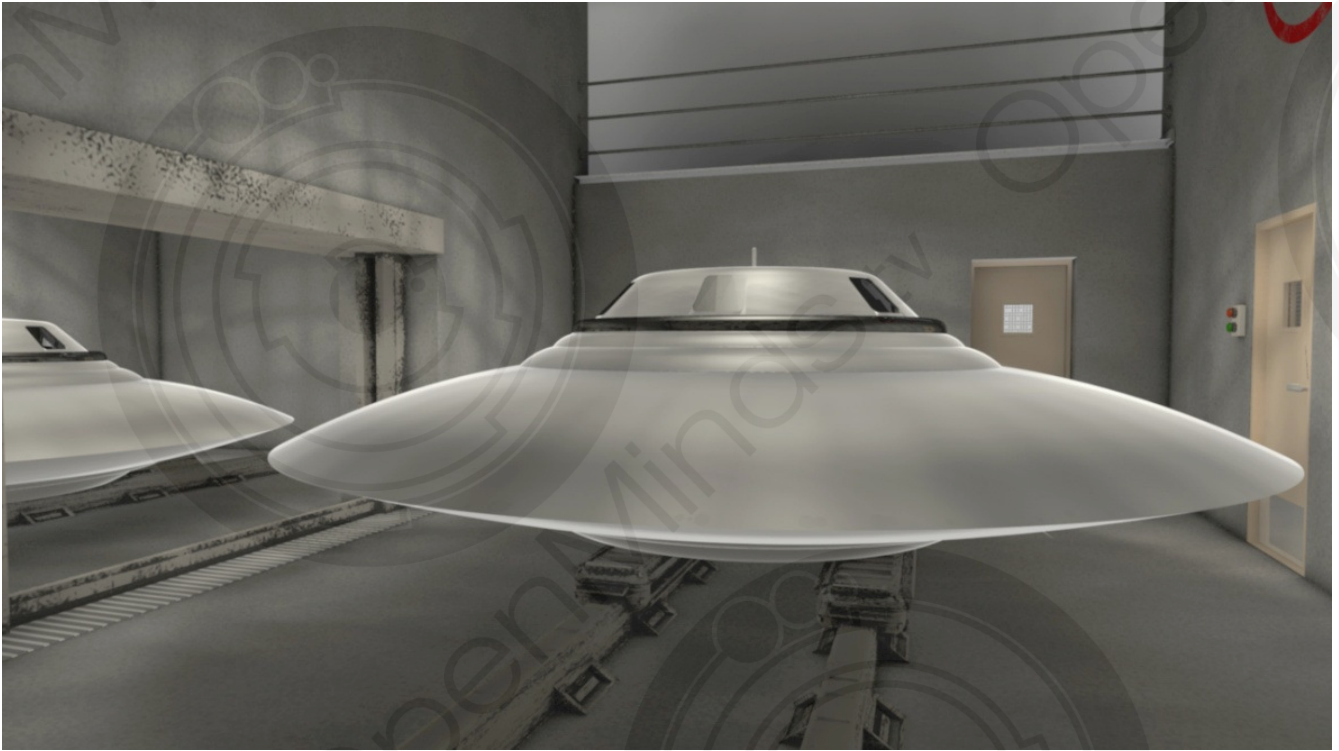

View of the Sport Model from the perspective of ground level looking back at the catwalk. *

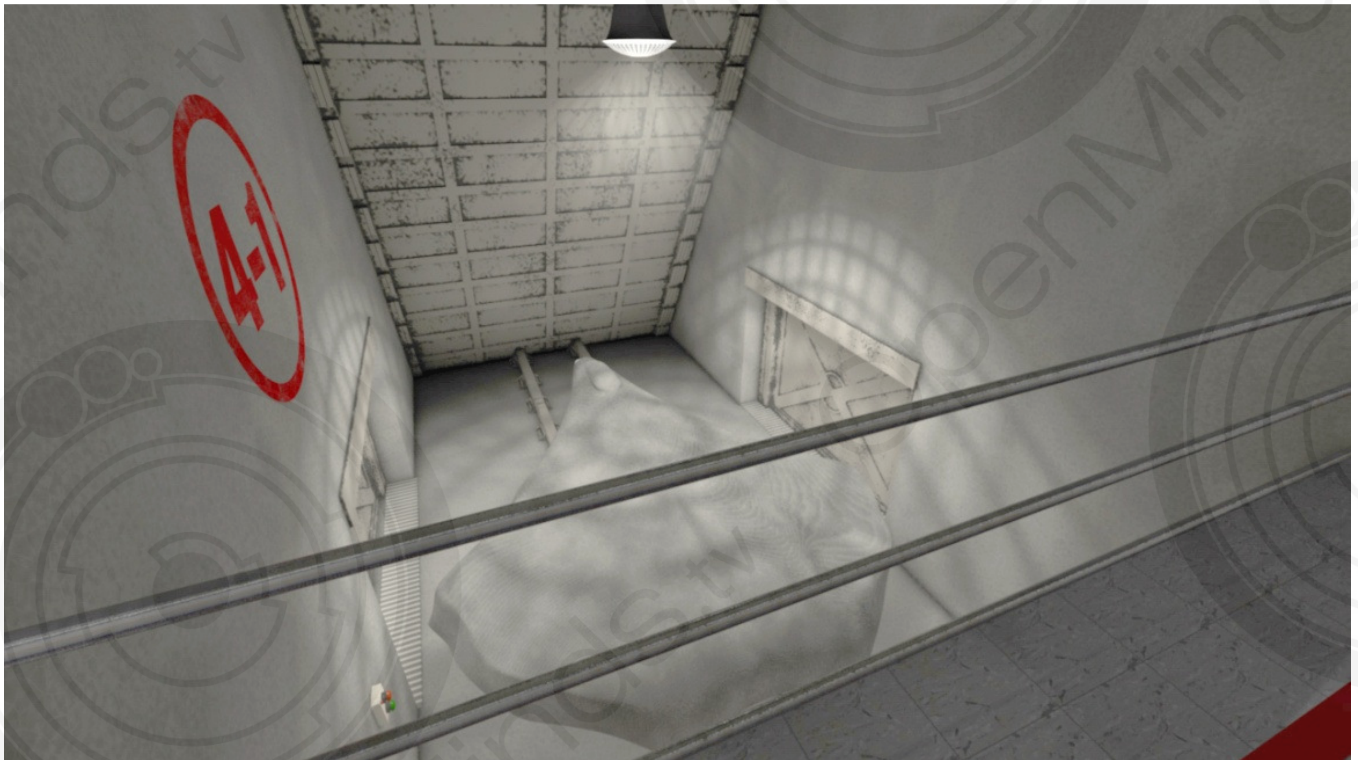

View of tarp covered P24 Roswell craft in hangar bay 3. *

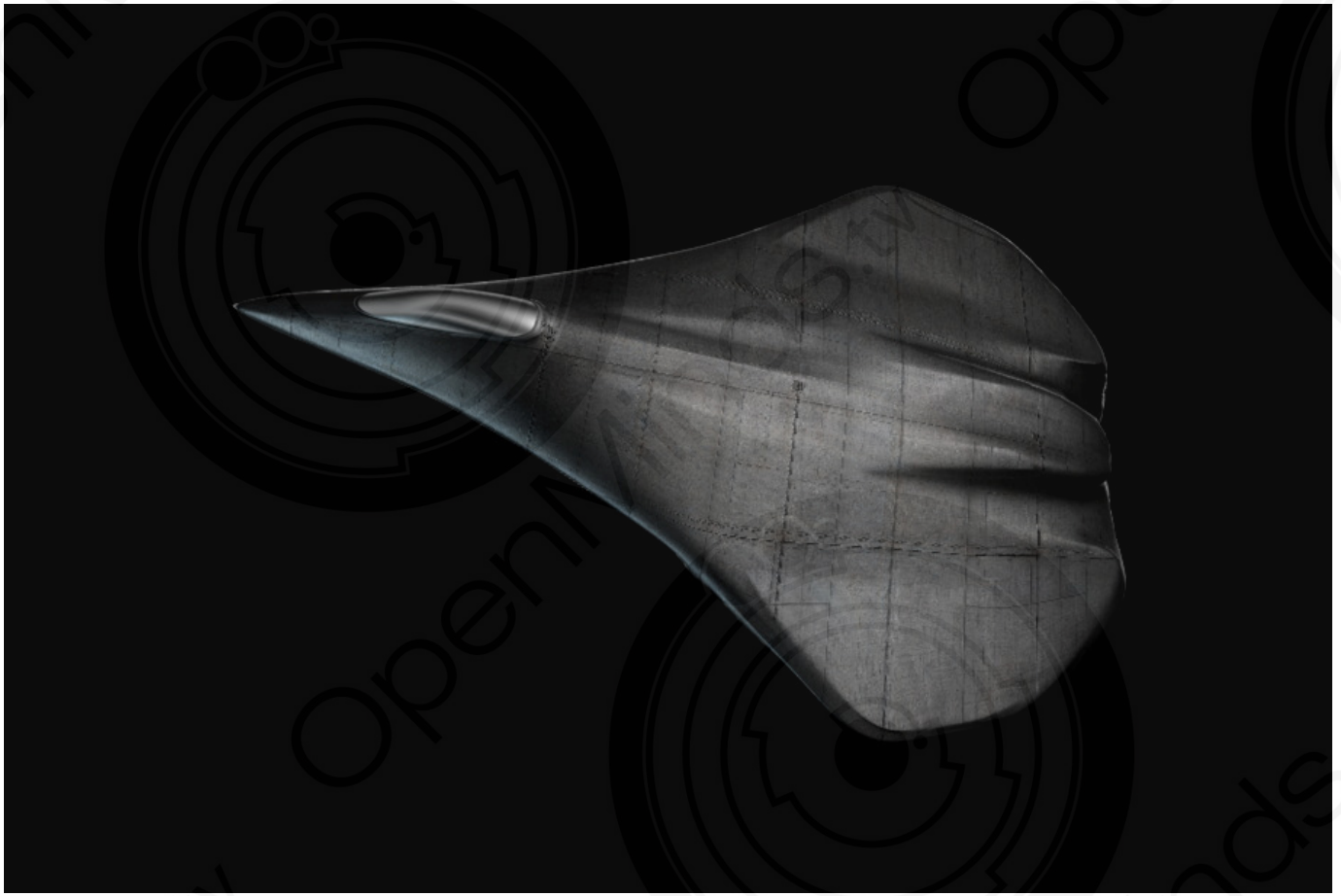

P24 craft with tarp removed showing smooth contoured blended configuration which formed the basis for the Lockheed Martin F-22. *

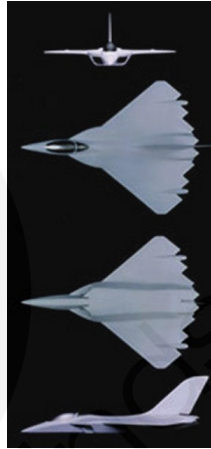
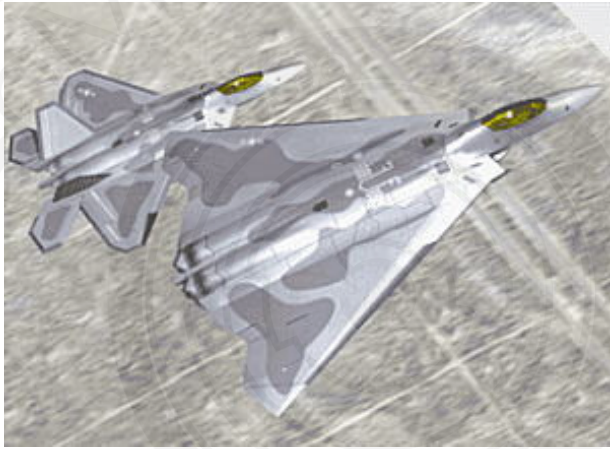

INVISIBLY BEAUTIFUL.

The Northrop/Loral **F-19A SPECTER** pursuit fighter is the next-generation of stealth and speed in flight. With a radar cross-section smaller than a duck in flight, an IR heat signature nearly as low as the heat background, and a noise level so quiet, it won't be heard until the engagement is over, the F-19A is invisible to everything but the human eye. Beauty is in the eye of the beholder, and the F-19A succeeds in all cases.

Radar Visibility	
F-20 Tigerhawk	Radar Signature Dominant
Duck	
F-19A	

NORTHROP LORAL
Making Advanced Technology Work
1840 Century Park East, Los Angeles Calif. 90067 USA



Both Dr. Dan Burisch and Phil Schneider confirm that a significant percentage of today's "Stealth" technology can be traced back to ET vehicles that were recovered by the U.S. military. Note fully blended wing-root to fuselage joint.



According to Dan, the exterior configuration of the F-22 including the advanced flight control surfaces, were reverse engineered from the P24 Roswell craft, and then underwent further aerodynamic improvements for military applications.

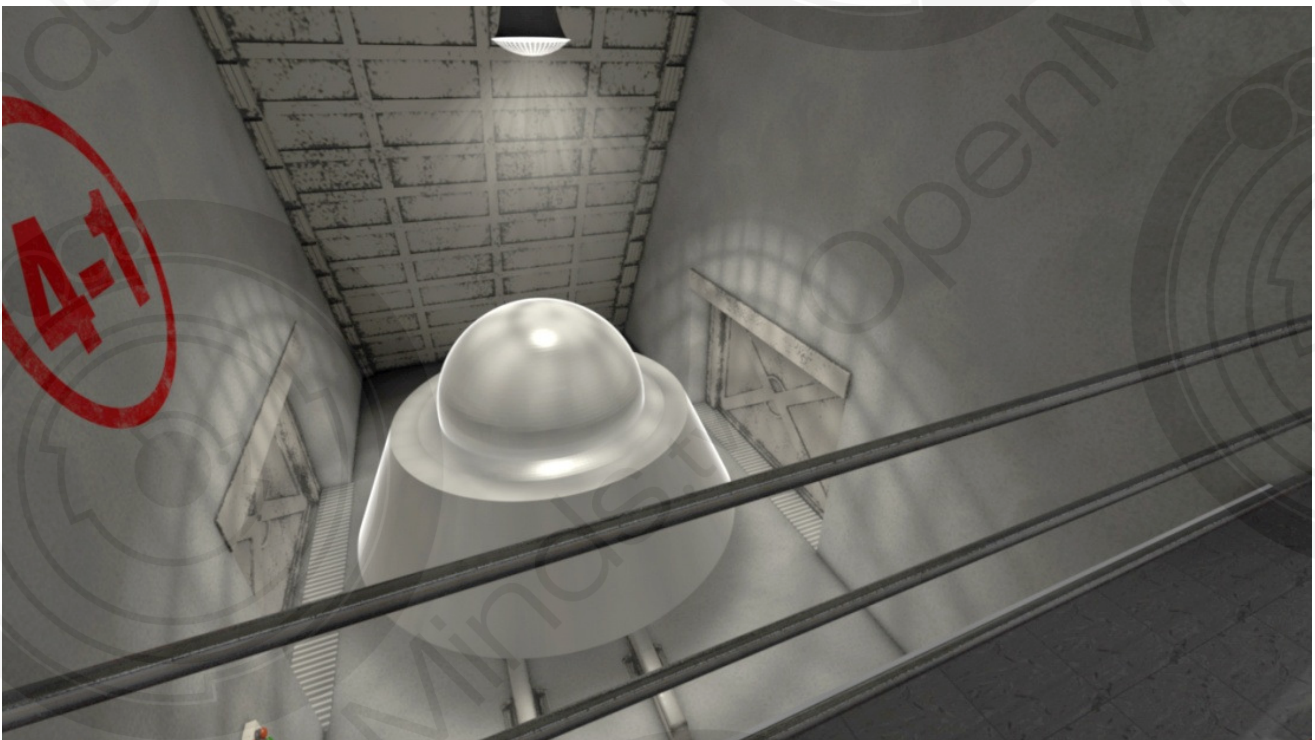

View of P52 "Orion craft" in hangar bay 4. *



Illustration of P52K "Orion craft" by Dr. Dan Burisch

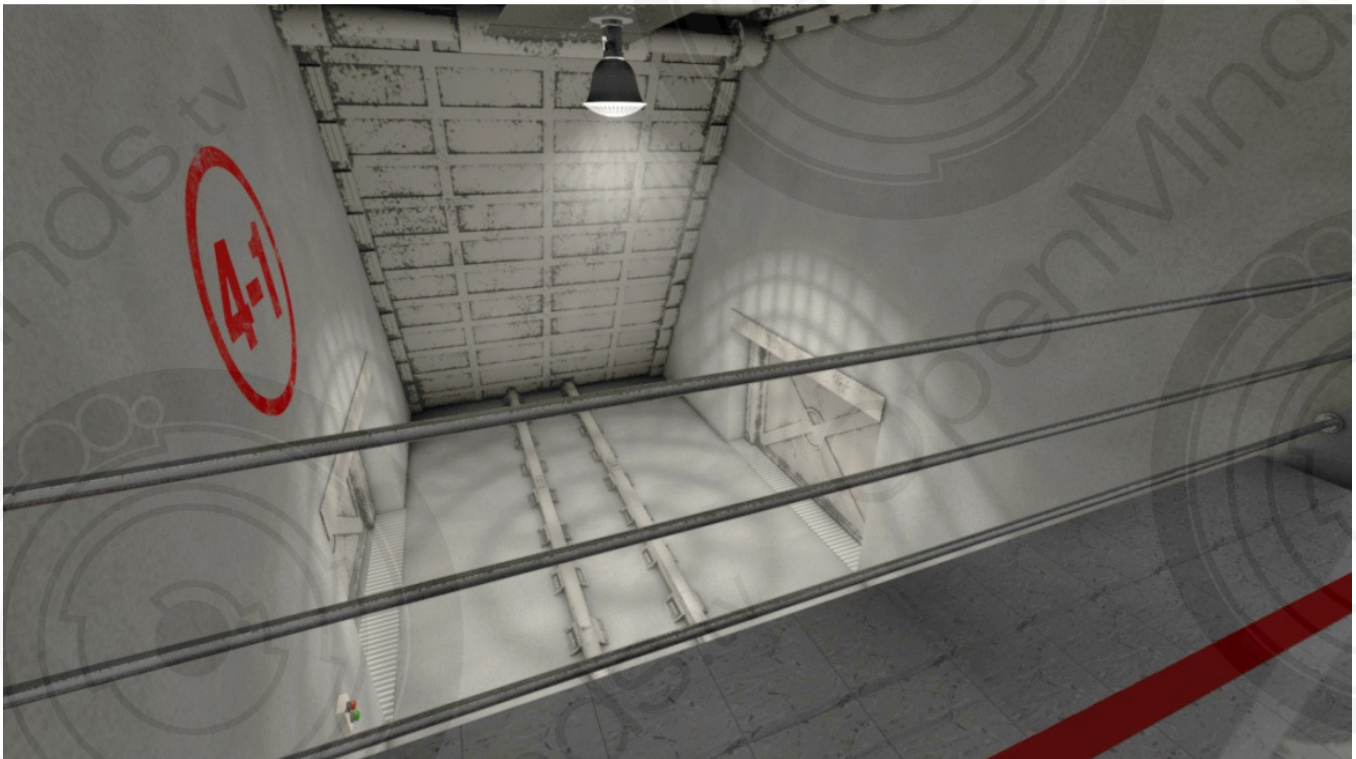

View of empty hangar bays 5 and 9. *

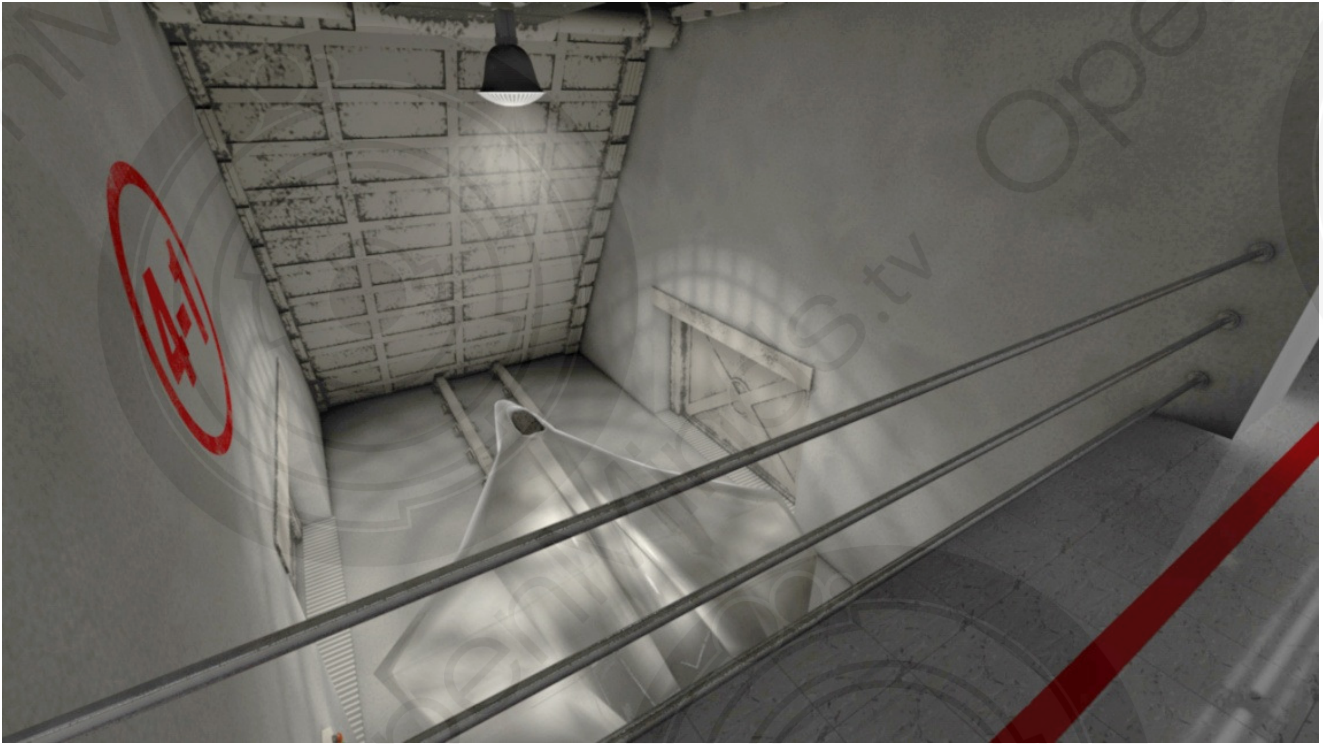

View of “man-made” P24 Roswell craft in hangar bay 6.*

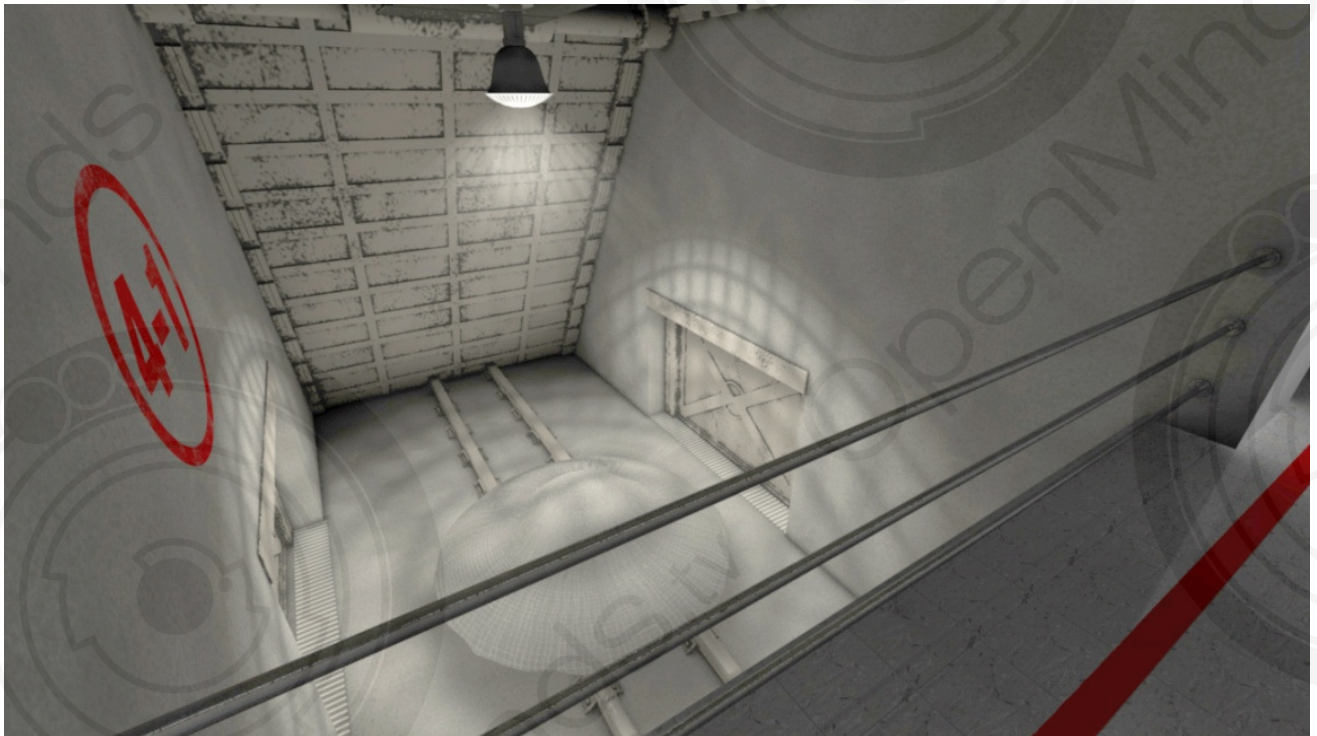

View of tarp covered craft in hangar bay 7.* (Tarp was actually black in color)

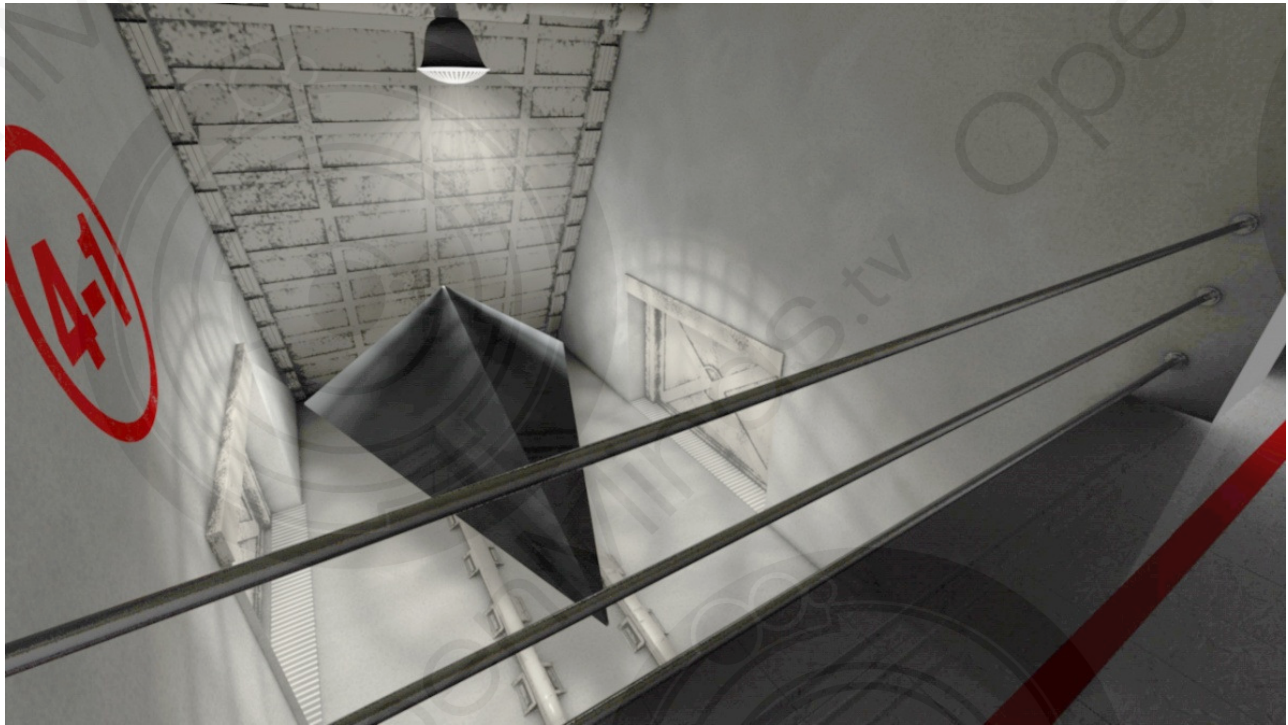

View of black “licorice drop” isosceles triangle in hangar bay 8.*



Immediately to the left of the entrance way to the S-4 facility an “I want to believe poster” was mounted on the wall (see above). In the propulsion research laboratory, disassembled wave guides (from the craft in the hangar bays) were being studied to determine their mode of operation. To the right of the avionics laboratory housed the briefing room. In this area Training Update Tapes or “TUTS” were housed along with DTIC (Defense Technical Information Center) blue 3-ring binders and booklets. This area also contained specific details on an extraterrestrial species known as the “Orions”. Additional information contained in the briefing room included details on the Zeta Reticulum star system, government weapons, and a copy of the 1954 agreement made between President Eisenhower and the P-52 Orion extraterrestrials.

Immediately to the left of the avionics lab, was a storage facility which housed components for Project Sidekick. According to Dan Burisch, the S-4 facility was poorly lit with the exception of the laboratory areas and levels 4-4 and 4-5. The walls of level 4-1 were painted gray, with an eight inch thick orange stripe running diagonally down the length of the hallway. All hallways in the facility had security camera domes mounted approximately 12 inches from the ceiling, and spaced every 10 feet. Parallel blue and red stripes were painted on the floor of many levels of the facility. Nine hangar bays (which were built into the sides of the Pappoose mountain range) housed multiple craft of different configurations.

Level 1, also known as “4-1” (derived from Area S-4 Level 1 or “4-1”) included the so called “Galileo bay” which housed many different models of flying craft. When Bob Lazar reported that he worked at the facility during 1988-1989, he said there were nine craft visible in the bays, including the “Sport Model”, and other configurations. When Dan worked at the facility from (1991-1996), he observed five craft with two hangar bays being empty, and two bays housing objects covered with black tarps.

When Dan observed the Galileo bays, he saw bay 1 which contained a craft from the P-45 J-Rods. The configuration of the craft in this bay as well as the craft in bay 2 (an ARV based upon the craft in bay 1) resembled the overall description of the “Sport Model”. Bay three housed a craft reported to Dan as being the original Roswell craft that crashed North of Roswell on July 3, 1947. This particular craft was covered by a tarp making it difficult to make out the exterior details. Bay 4 contained the “Orion” craft which some people have likened to a Jell-O mold. Hangar bay 5 was empty. Bay 6 contained what Dan was told was the reproduction vehicle from bay 3’s Roswell craft. Dan was told that the control surfaces on the F-22 Raptor had elements from the original Roswell craft’s control surfaces configured into them. It was described as looking similar to a Lockheed Martin F-22 “Raptor”, but with the vertical stabilizers and air-intakes removed, and the position of the cockpit canopy moved forward. The original Roswell craft was a P-24 earth to earth terrestrial craft capable of moving through time and maintaining lift in the atmosphere. This man-made craft also had highly smooth/rounded contours similar to the Northrop B-2 Stealth Bomber.

Bay 7 contained an unknown craft, or other device which was covered by a tarp. Bay 8 housed a black isosceles triangle which was described by Dan Burisch as looking like a “licorice drop”. Bay 9 was empty. All nine bays had two small slits on the hangar floors which retracted back, provided access to the “sub floor” level, aka “4-1B”, which also extended just ahead of the hangar bays (see floor layout drawing). This unique area contained a large pylon with a rotating gimble. Disc shaped craft could be placed on top of this assembly which was used as a flying saucer flight simulator (see drawing below). This equipment corresponds to the testimony of Bill Uhouse, (and also from his son Will Uhouse) of the equipment that Bill Uhouse designed with the assistance of another J-Rod in the Area of Los Alamos National Laboratory. Two of the three J-Rods from the 1953 Kingman AZ crash survived the crash. One, a P-45 J-Rod was taken to Los Alamos National Laboratory and worked with Bill Uhouse on this flight simulator equipment. The other survivor, a P-52 J-Rod was subsequently housed at S-4/5 in the Papoose Lake facility, and was the one with whom Dan had interaction. Bill Uhouse and Dan Burisch’s accounts were independently documented by William Hamilton.

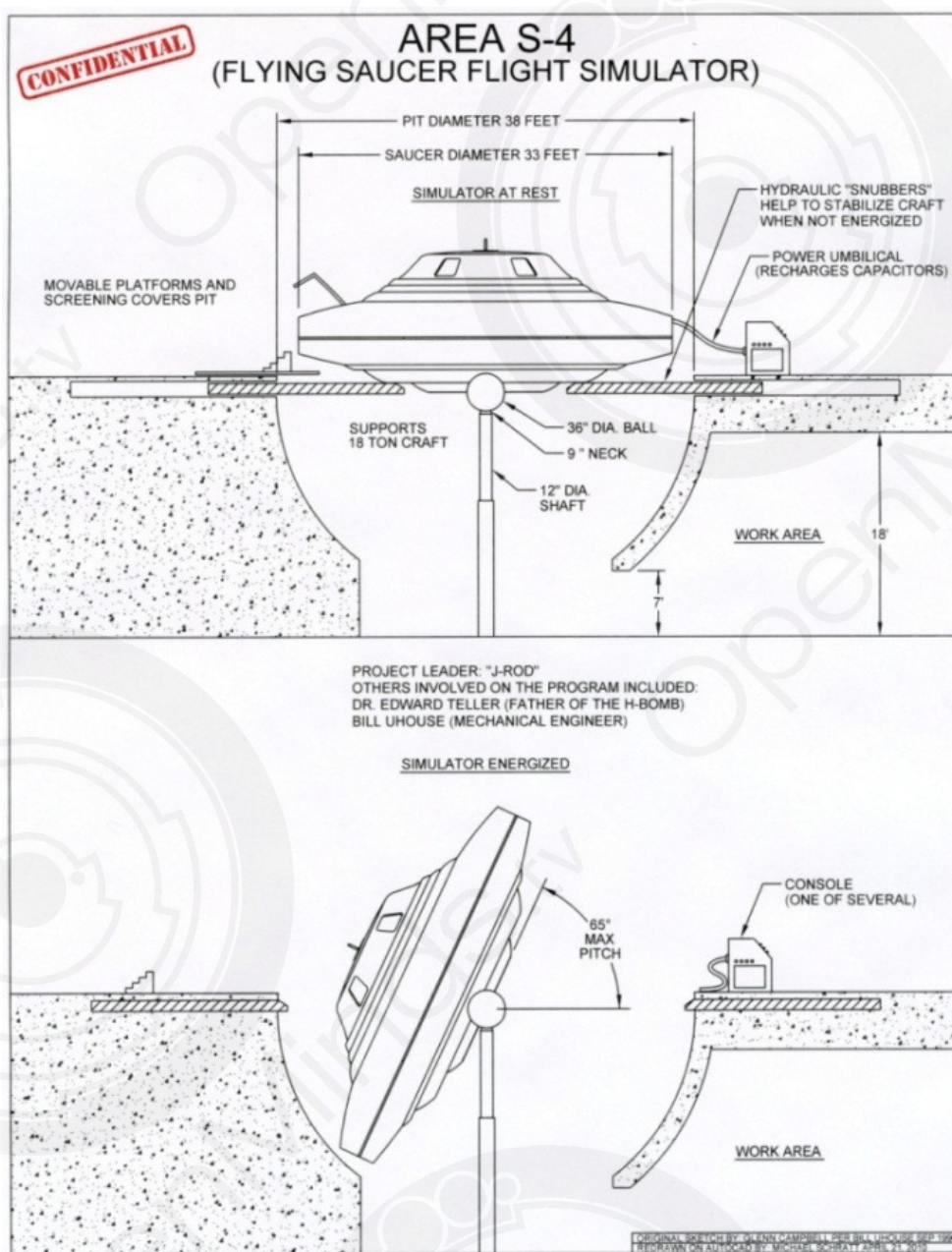

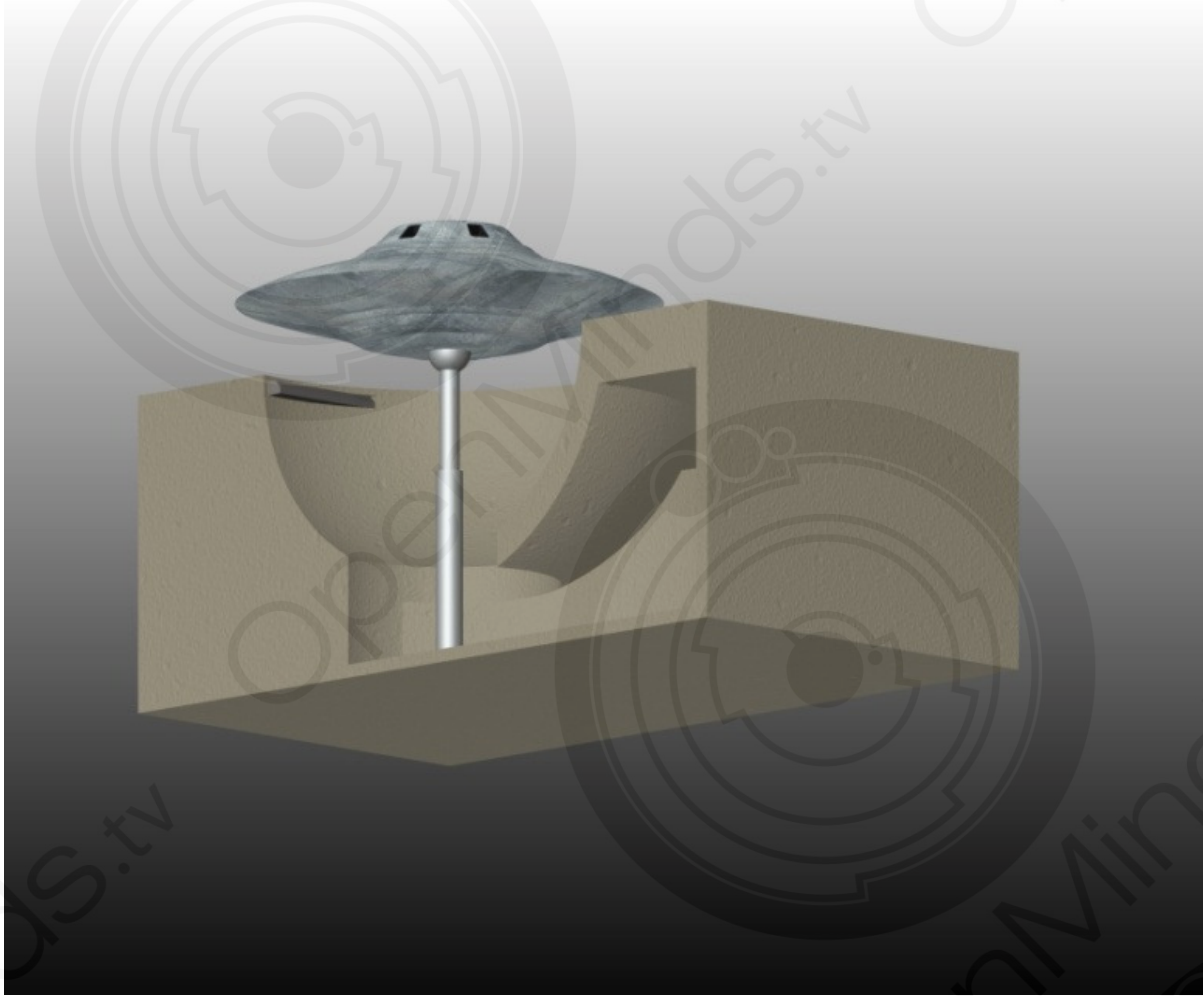

The top line drawing above originates from Bill Uhouse, who said that he was hired to help develop and build flying saucer flight simulators at Area S-4 and Los Alamos National Laboratory. These simulators were specially configured to teach American test pilots how to operate disc shaped ARV's designed from the extraterrestrial original models. Human pilots were not able to operate the original craft because the small, full body molded apparatus that a person would be required to fit into in order to pilot the craft were simply too small, even for the smallest test pilot. The P-45 J-Rod craft contained three full body molded seats for pilots, positioned at 60 degrees around the circular control deck.



Measuring slightly less than 50 feet in diameter, and approximately 13-14 feet high, the ARV based upon the original P-45 craft (the so-called "Sport Model) had a surface that appeared like brushed aluminum or titanium. The original craft was aesthetically more pleasing, and appeared to have a titanium-silicon composite surface. The craft had an upper, middle, and lower deck. According to both Bill Uhouse and (Ret USMC) Charles L. Suggs, the avionics for the "Sport Model" are housed in the upper deck. Per comments made by Bob Lazar (government physicist), the middle deck is comprised of three small chairs, three gravity amplifier heads, and one wave guide. The lower deck contains three so called "gravity amplifiers". Human pilots had difficulty interfacing with an unknown extraterrestrial avionics system, so efforts to build man-made ASC (Alien Simulated Craft) began in the mid 1950's.

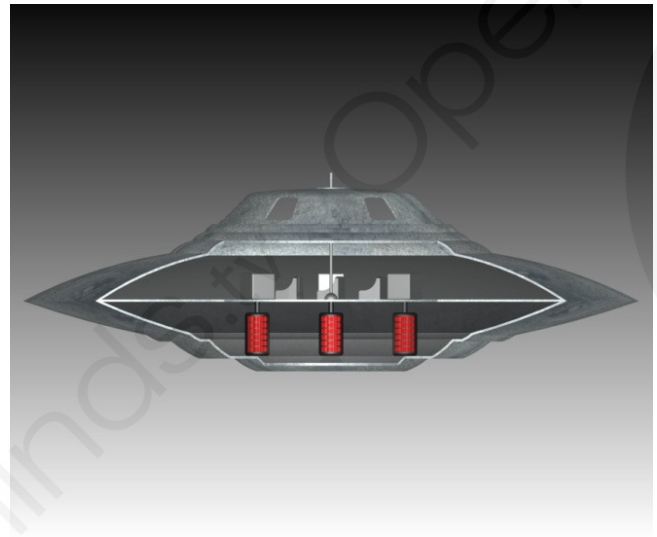

According to the previously mentioned individuals, these are cut-away illustration of the Sport Model showing the internal details of the craft that was housed in the “Galileo Bay” of Area S-4. No electrical wires were found to be inside the vehicle, indicating that there may have been a “neural network” or brainwave frequency connection between the flight controls, and the occupants. Note enlarged view of the “Sport Model” showing the three seats on the mid-deck, and gravity amplifiers on the lower floor. For flight near a pre-existing gravitational field, only the center gravity amplifier would be used in the so called “Omicron configuration”. For travelling in deep space, all three gravity amplifiers would be focused on a single point known as the “Delta configuration”.

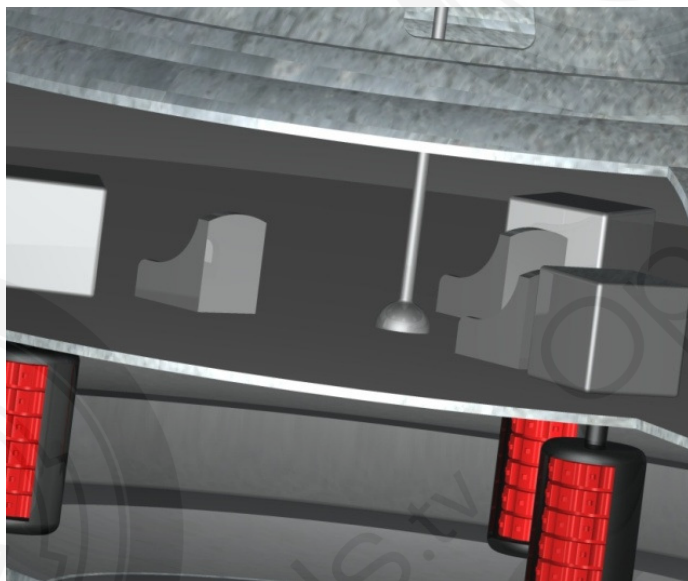

According to Bob Lazar, the power source for the “Sport Model” came from “Element 115”. This element was loaded into the anti-matter reactor and bombarded with protons. When a proton plugs into the nucleus of an atom Element 115 it increases its atomic number to Element 116, which decays instantly. What Element 116 releases as it decays is antimatter, which is the power source of the craft. What Bob Lazar did not say was that the spontaneous decomposition of Element 115 was counteracted by the presence of other materials which acted in a supportive fashion to Element 115.



Illustration of craft recovered from the Kingman UFO crash of 1953.*



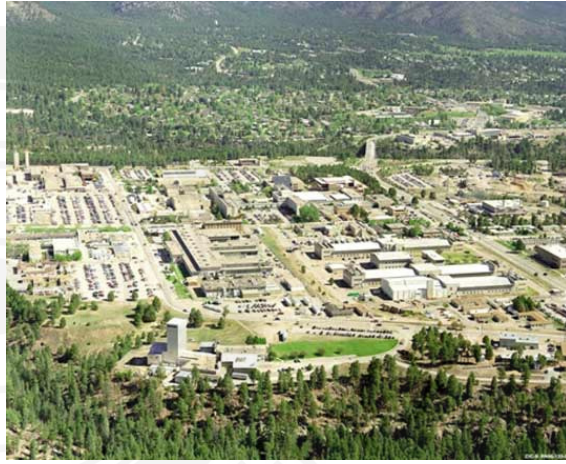

(Los Alamos National Laboratories)

When the vehicle crashed in Kingman AZ, one of the first units to respond was dispatched out of Utah, part of Project Pounce (Laundry Team). They expected to find no one alive, so the Laundry Team was supposed to clean up any bodies and crash material, and return it all to a facility in Utah. Upon arrival, they found the disc wedged open because it crashed into a rocky area. One of the three occupants was ejected upon impact along with his bio-containment seating unit which was still around him. He was declared dead at the scene. The two other bio-containment seating units were still functioning. The Utah unit then requested pressurized chambers to be rushed to the crash site. One of the J-Rods began communicating with the Pounce unit telepathically in broken English, indicating that their destination was the Los Alamos area.

The other J-Rod also communicated although the stories were slightly different. They noticed that the way he symbolically spoke to the Pounce unit was different than the way the other J-Rod was phrasing his telepathic communication. The Pounce unit communicated with Los Alamos, and was told that there was a P-45 disc expected to arrive for participation in a Sigma-communications team project. Upon arrival of the Los Alamos unit in Arizona, they determined that the one J-Rod was not a P-45 J-Rod (as they expected), but a P-52 J-Rod that they knew nothing about. The decision was made at that point to separate the two living J-Rods. One went to Los Alamos, and the other (which Dan worked with in the Clean Sphere) was taken to Area 51.

The P-45 J-Rod that went to Los Alamos continued in his Sigma project efforts after recovering from the crash. His job was to assist our people in back-engineering flight simulators that would operate the P-24 type Roswell craft. Bill Uhouse was given disinformation with respect to the number of crash occupants, and was not told about an unusual J-Rod (the P-52) being on the crashed craft. After working with Bill Uhouse for a while, the P-45 J-Rod at Los Alamos was offered a deal to provide flight simulator information for the P-45 disc to Bill and his team, or be reported dead to his own people (just like the deceased occupant was). He agreed to the deal, and supplied the flight simulator information for his disc, the P-45 "Sport Model". A few years later after transport back and forth between Los Alamos and the S-4 facility, that P-45 J-Rod was allowed to go home.

After the P-52 J-Rod had arrived at Groom Lake, Majestic arranged for him to be in a more suitable environmental containment condition. He was then transported via ground team to the Papoose Lake facility (S-4) to be put into the offensive biological warfare animal testing system. This containment testing system became known as "The Clean Sphere". Having taken over that area for containment of the J-Rod, Majestic arranged for the offensive biological warfare personnel to be moved to Camp Detrick. At this point, the power-brokers quickly arranged for funding so that those in charge of the warfare program would not complain about the quick change of facilities. Camp Detrick and enhanced funding can be tracked to that year.

The P-52 J-Rod identified himself as coming from the direction of the Aquarius system. The Air Force's control over what then became Project Aquarius was quickly wrested away from the Air Force by the Navy

because the naval members of Majestic had surmised in reports that there should be people beyond the P-45 time frame, where as the Air Force had concluded, after listening to the lies from the P-45's, that there could not be anybody beyond their time frame, even though the P-45's themselves had surmised that there could be, but had no proof of it. Unable to communicate with the P-52 J-Rod's home people (until he provided engineering schematics and where to find them for the Looking Glass and Stargates) the P-52 was held captive – an anomaly- and a potential alien spy. The craft was brought to Area S4 most likely by way of a large overland transporter, such as the U.S. Army 40 ton “Dragon Wagon”. The whereabouts of his craft remain unknown to Dan, but he surmises that the object under the tarp in bay 7 may have been the disc from the 1953 crash.



In the year following the 1953 crash, President Eisenhower was summoned to the Edward's Air Force Base area to meet with the P-52 Orions. The main subject of the meeting was the imminent future of humanity, and to prevent hostilities between the aggressive P-45 J-Rods, and their newly recognized counterparts, the P-52 J-Rods. From this meeting, where President Eisenhower was presented with the Orion Cube, formal diplomatic discussions began between all parties, with the Orions leading the way. The origin of the animosity between the CIA and the NSA control of Majestic operation events, where they pertain to extraterrestrials has its origins in the 1953 crash, and creation of Project Aquarius.



The CIA and the Air Force's control (AFOSI) of the events fell through with the acknowledgement that their Naval counterparts were correct in an assessment of more varieties of extraterrestrials. Because the Air Force's intelligence assessments failed primary control of Project Aquarius was given over to NSA cryptologics and the Navy. This angered the Air Force and CIA, both having their origins in the National Security act of 1947, in an environment where extraterrestrials were just deemed time-travelers. The “new kids on the block” from 1952, the NSA was given the nod from within Majestic, causing a rift (behind the scenes) that exists even today. Dan was raised within Majestic on the NSA side of the equation, under the wing of the former leader of Majestic 12. Marcia was raised by her father, a highly placed courier for Majestic, also on the NSA side of the equation.

The difference between them and certain CIA whistle blowers is easily observed. To them, it's just a matter of right-upbringing and the underlying knowledge of social graces. The NSA side of the equation remains in control of Majestic operation as it concerns the extraterrestrial question. There is no sign that this balance will change.

AREA S-4 SUB FLOOR LAYOUT
(LEVEL 2)

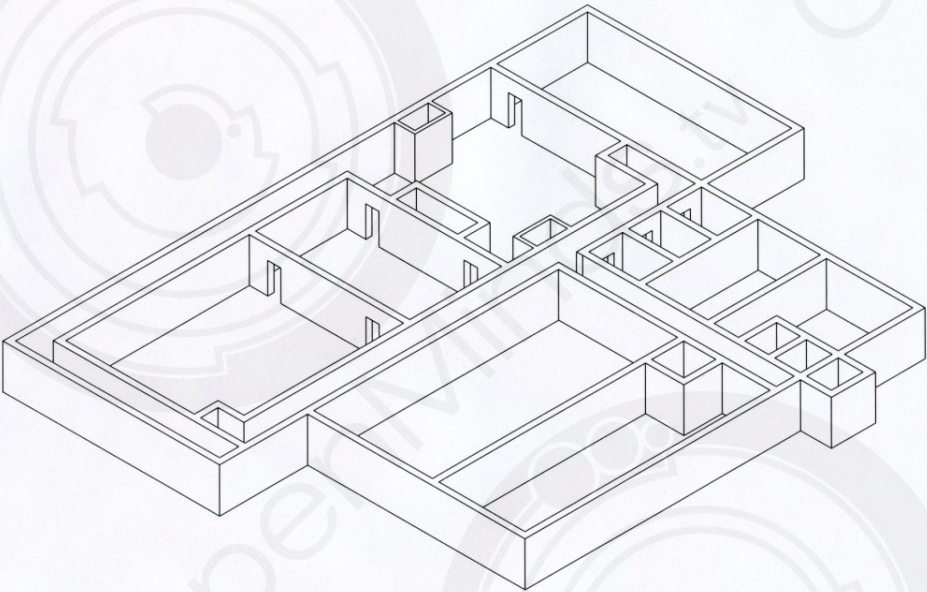

DRAWING BY MICHAEL SCHRATT 3/4/10
PER DESCRIPTION BY DAN BURISCH

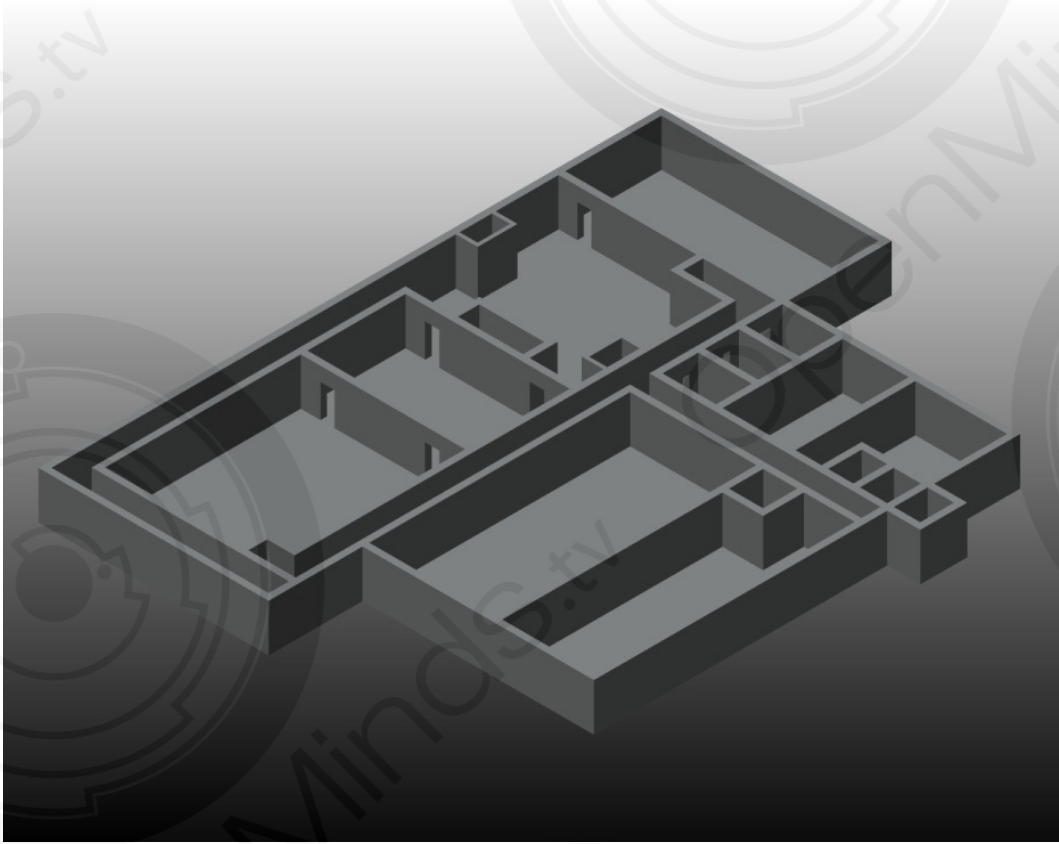

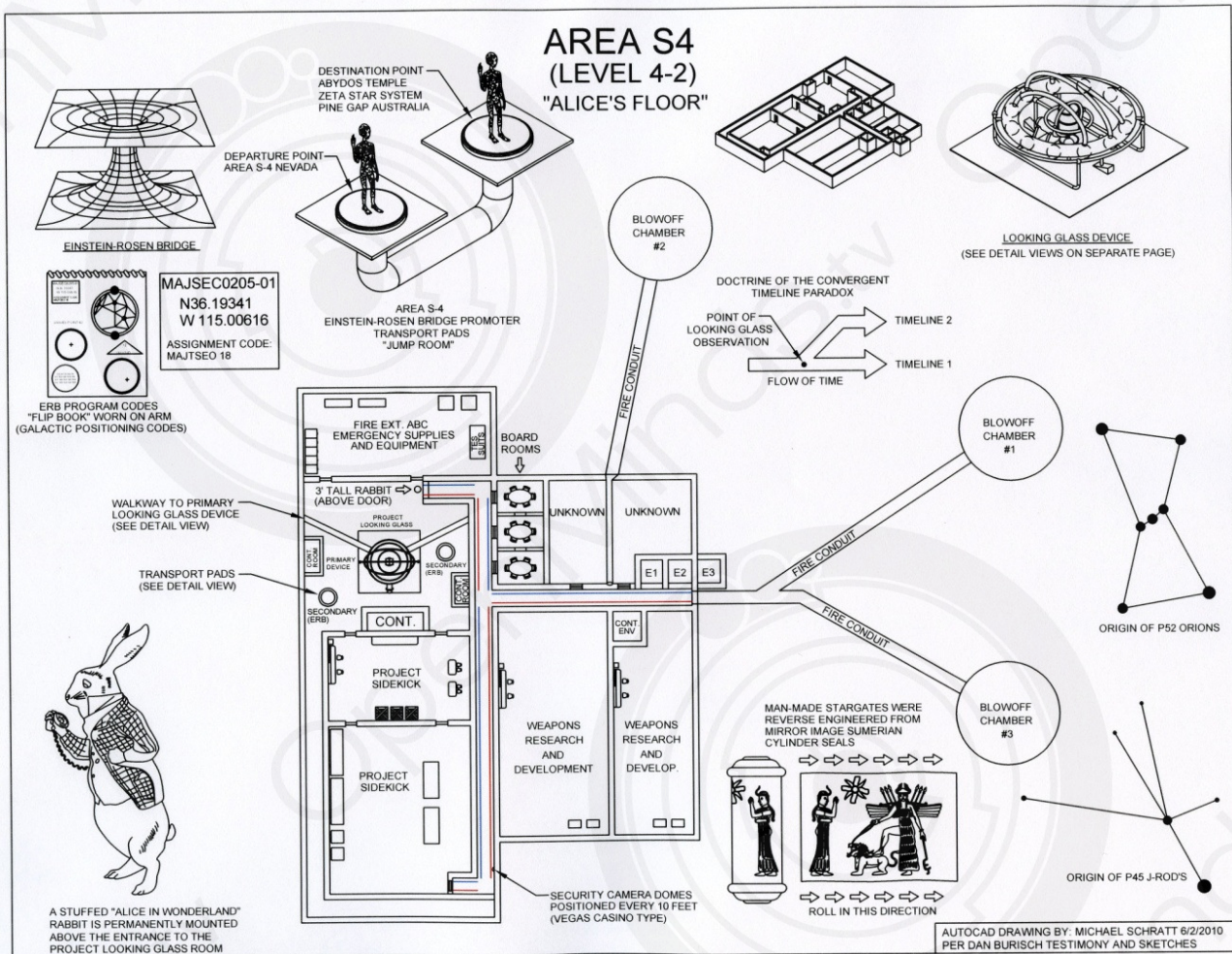

Level 2 or “4-2” was known as “Alice’s Floor”. This specific floor contained a laboratory for weapons research and development, three board rooms, and provisions for emergency supplies. Also located on level 4-2 were two specific areas which contained components for project sidekick. Level 4-2 was also the location of Project Looking Glass. This device utilized six (composite) electromagnetic fields, and a height adjustable rotating cylinder which is injected with a specific type of gas. The entire assembly can be rotated 90 degrees from the horizontal axis. This allows scientists to warp the local fabric of space-time both forward or backwards by long or short distances relative to the present time. The Project Looking Glass device was used to predict the potential probability of future events. Once the device is tuned properly, images of probable future events are projected in open space within the fields, similar to a hologram. The data output of the device (images and in some cases sounds) were then captured via high resolution audio-video capture devices. If multiple probabilities of the same event were displayed, they could be de-interlaced by use of specific software platforms. Next to the Project Looking Glass device were two “transport pads” which could teleport physical matter or humans from one location to the other instantly, but not always reliably and with certain disastrous outcomes during testing phases. Dan had the unfortunate experience of being in the room during one of those unfortunate outcomes, and witnessed a death.

During Dan's time at S-4, five concurrent programs were also being conducted. One named "Project Galileo", dealt with the propulsion system of extraterrestrial and future terrestrial vehicles. Another program termed "Project Sidekick" which Dan said relates to a weapons platform but refuses any further comment. The third project known as "Project Looking Glass" dealt with time distortion. More specifically, this program dealt with the physics of seeing the effects of an artificially produced gravity wave on time. The overall umbrella designation for the study of anything having to do with Extraterrestrial Biological Entities, and their interaction with humans on earth was known as "Project Aquarius". The fourth project was a separate weapons program developed as a second generation research program from Project Sidekick. Dr. Dan refuses to provide the official project name for that program. The other program involved a suite of biological defense operations for which Dan worked in the capacity of senior scientist. No further information will be provided for that program.

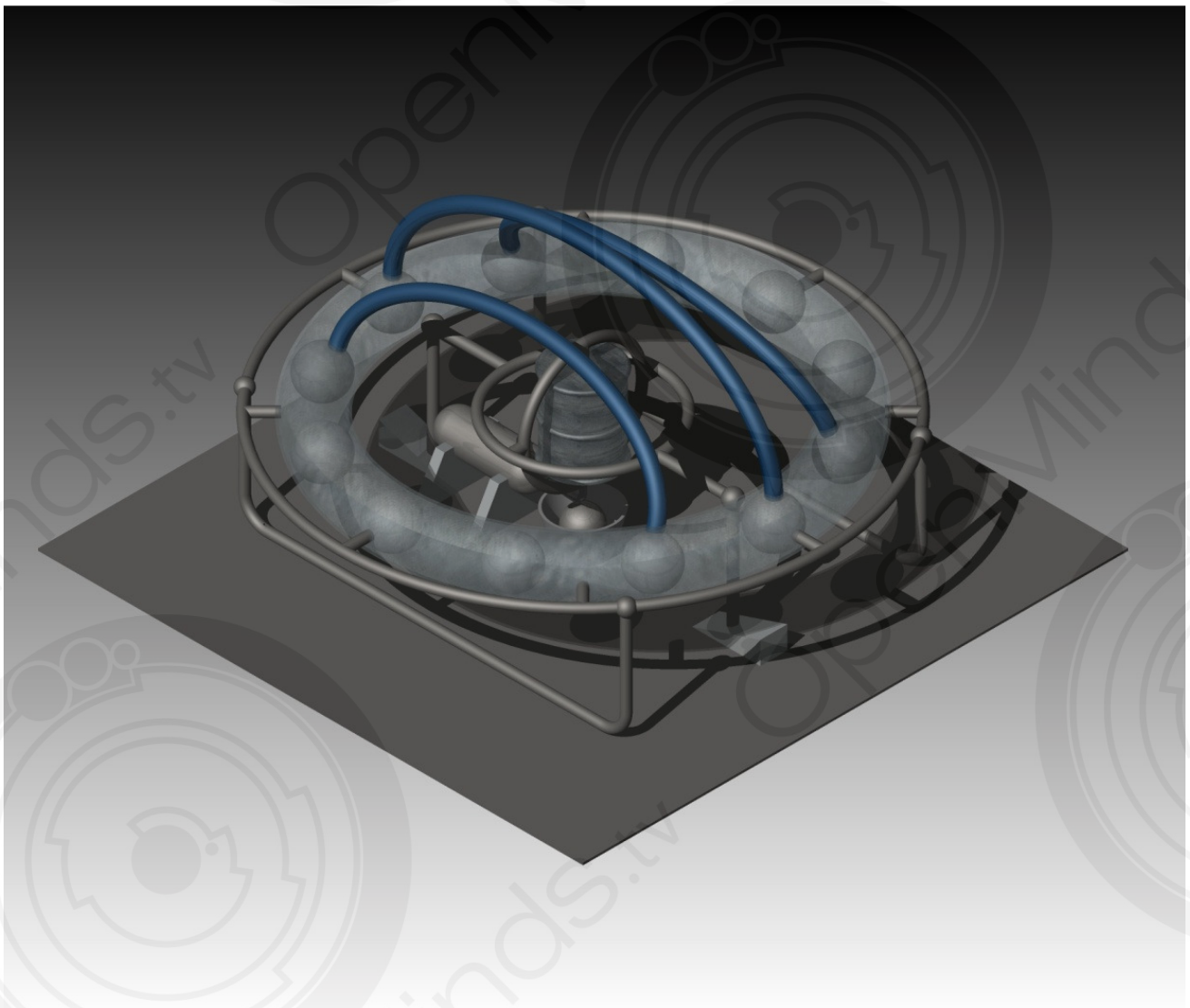

View depicting the Looking Glass device found on Level 4-2 of the S4 facility.*

The looking glass device at Area S-4 (level 4-2), used a barrel housed within the center hole of a doughnut-shaped structure. During operation, Argon gas was sprayed into the center of the rotating barrel. A number of powerful electromagnets encircled the barrel, and as the power is fluctuated into the magnets and the orientation of the magnets is changed, it dials into the probabilities within hyperspace, contacting wormholes to various probabilistic universes. According to Dan and Will Uhouse (a direct witness to early Looking Glass operations during the 1970's), the scientists working on the program quickly found out that the device was multi-functional. Through a variation of power settings and alignments, the device could produce images. It was soon determined that these images dealt with future events which might take place on earth.

According to Dan, it was soon determined what events would be causation events for the ultimate splitting of humanity into what could become the J-Rod's and the Orion beings. That information from the Looking Glass was supported by the direct testimony of both the J-Rods and Orion beings, according to their written and oral histories. It was further supported by observation of data from the quantum cube gift (Orion Cube) given to President Eisenhower in 1954. According to Dan, the Looking Glass devices and Stargates were dismantled in an effort to protect humanity, based upon the totality of information collected. There were also several other efforts commissioned by Majestic to derail the potential sequence of events that would have led up to the catastrophe.



Mayan Calendar

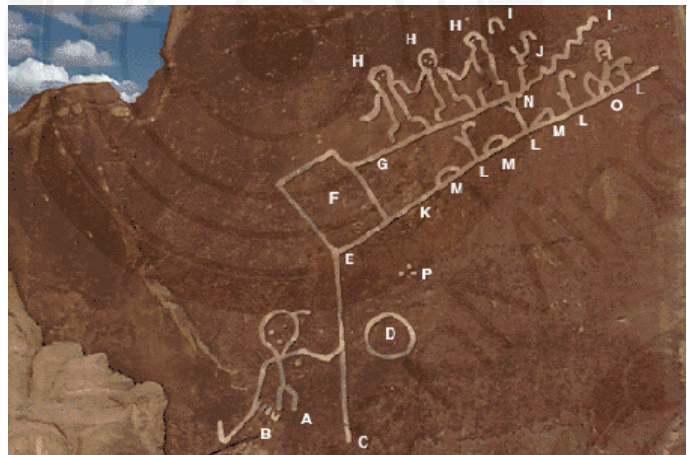

Hopi Prophecy Rock

Humanity has witnessed multiple prophecies about the times in which we live. Whether it be from Prophecy Rock, the Mayan prophecies concerning their calendar, or the prophecies of Fulcanelli. The take of some people on those prophecies is positive, while the take of others is negative. Both those groups are reacting within the probabilistics of the possible futures for humanity. The people who wrote the prophecies felt the same thing, and encoded them honestly so that we could experience them while making the right choices for our future. We have now arrived within that time, and the data provided to Dr. Dan from the J-Rod has indicated that the time of the catastrophe which resulted in the splitting of humanity has passed. This should mean to us that we have the opportunity to grasp the positive contained within these prophecies, as a means to direct our path to a positive future.



DOCTRINE OF THE CONVERGENT
TIMELINE PARADOX

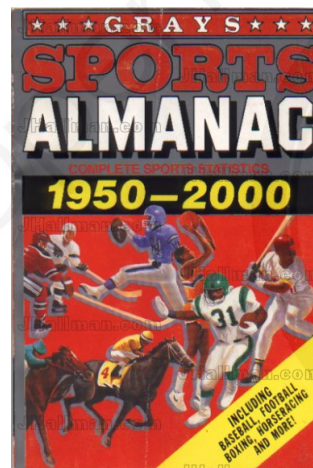
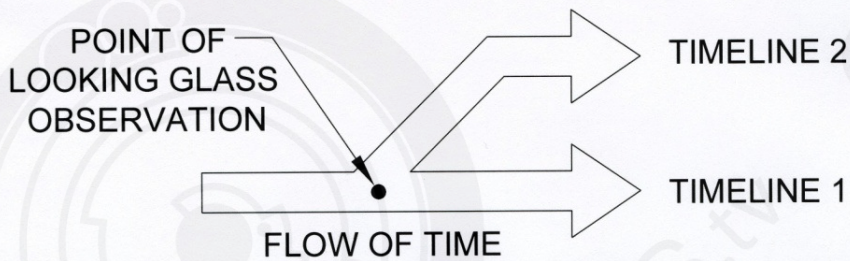

The “doctrine of the convergent timeline paradox” is well illustrated in the movie “Back to the Future Part II”.

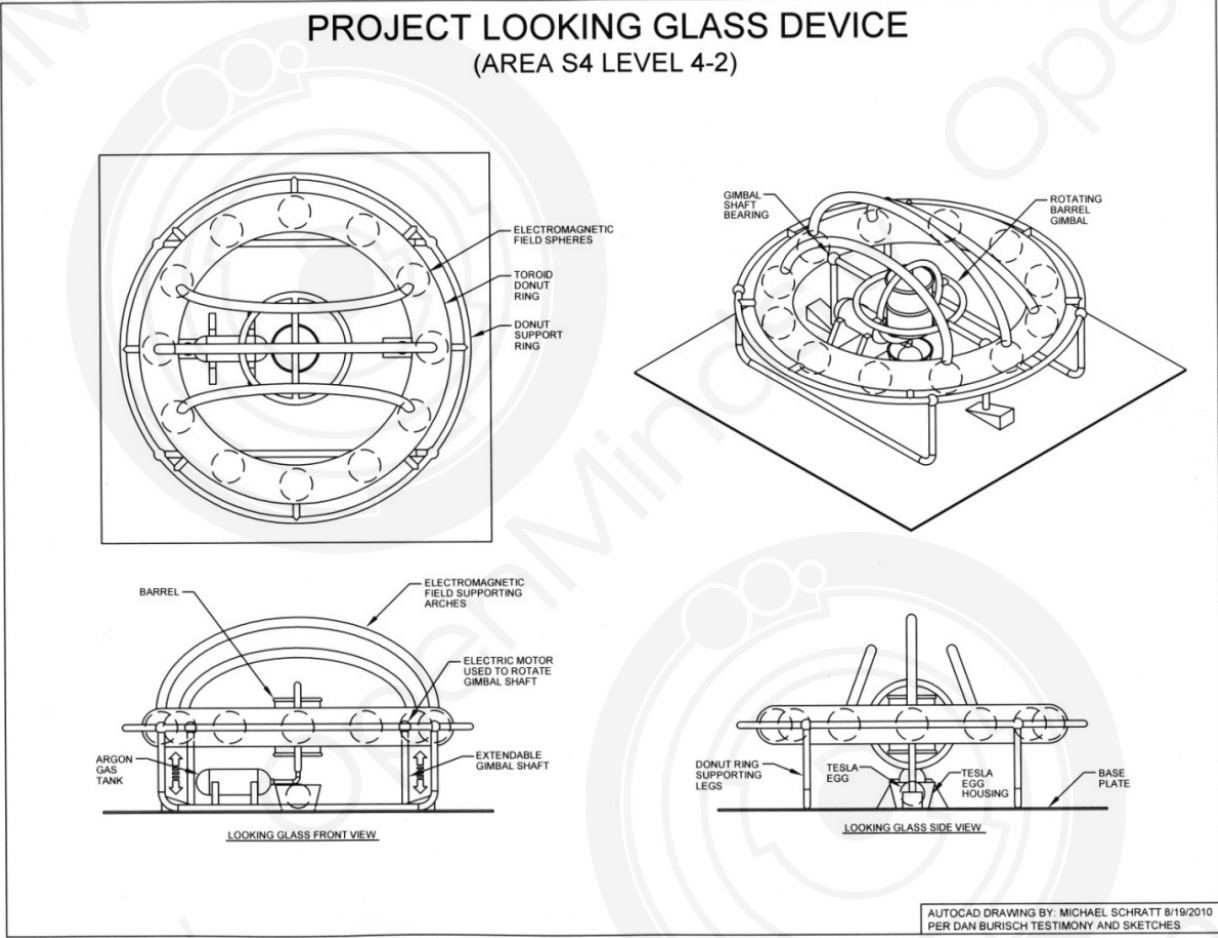

Three-view drawing of the Looking Glass device.*

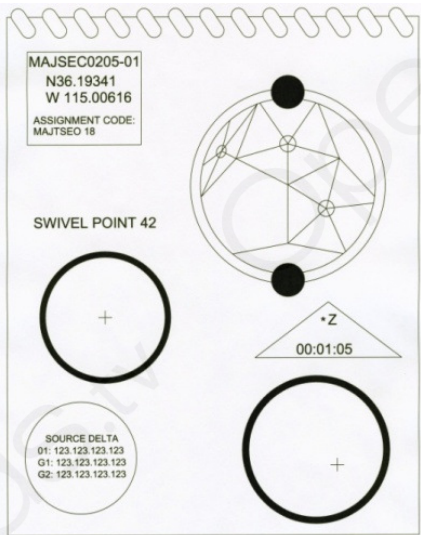

Per Dan’s comments, permanently wired above the entrance to the Project Looking Glass laboratory, there was a large three foot tall statue of a rabbit (symbolic of Alice in Wonderland). This rabbit was described as having a clock in his hand, and wearing a royal maroon vest, with gold fringes, and black buttons.

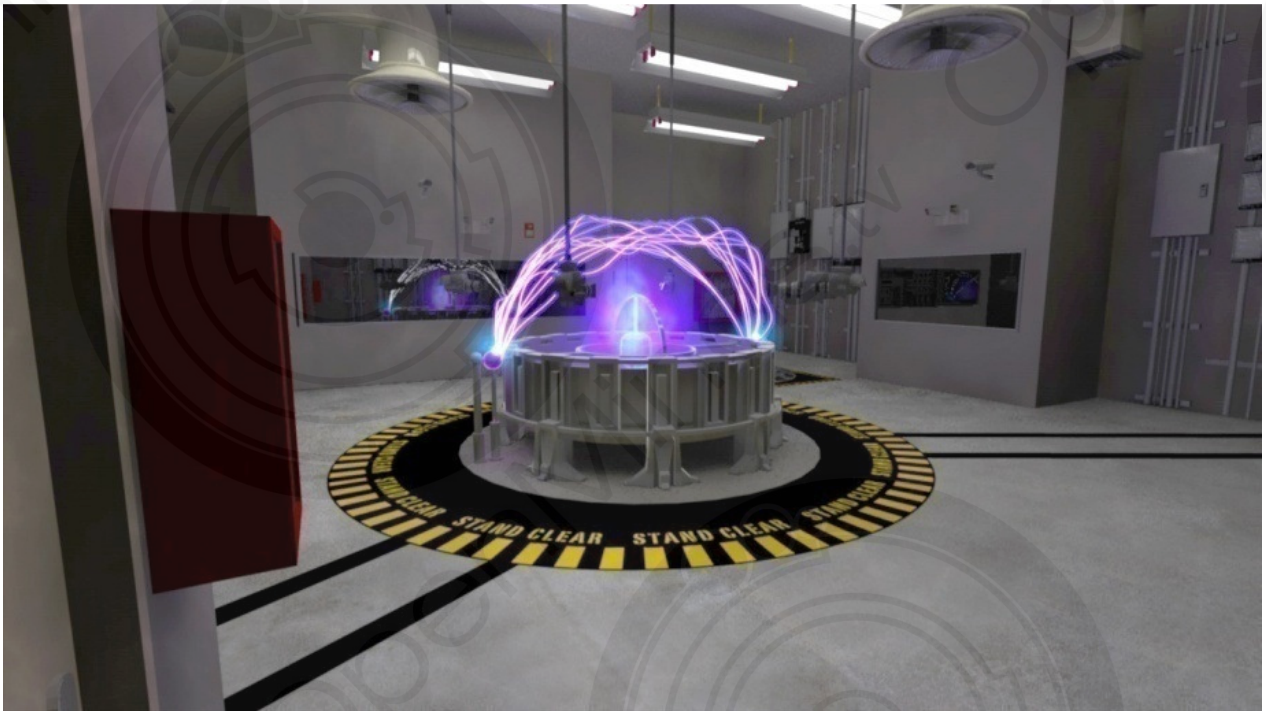

Note electrical field arcs above Looking Glass device.*



Note double walk-ways to Looking Glass device, as well as drum gimbal.*

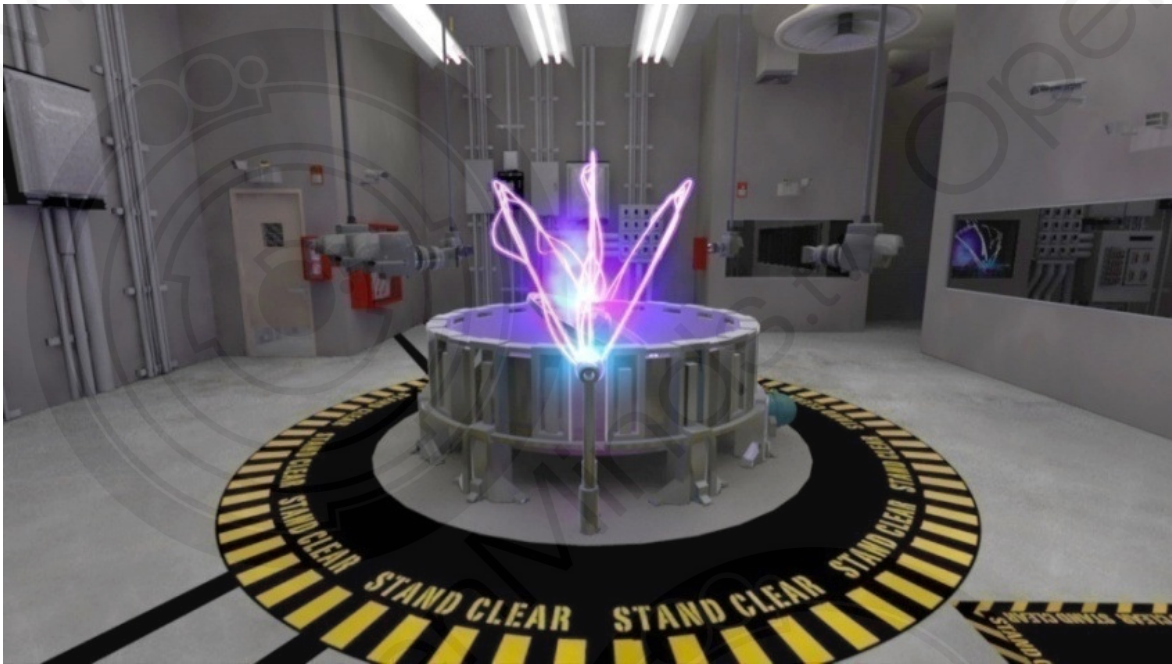

Close up view of Looking Glass device showing cameras, caution label on floor, and drum gimbal.*



Note the above depiction of a Stargate from the Hollywood movie. However, aside from some superficial similarities, the actual Stargates looked nothing like this. There was another Looking Glass device located elsewhere on the Nevada Test Site Range. The earlier version of that Looking Glass device was viewed by Will Uhouse in the 1970's. Two devices were required, operating at the same settings, for either of the two devices to emit sound associated with the probable events they were presenting as data. Dr. Dan being a microbiologist, and not having had further briefings about Project Looking Glass during the 1990's time frame, could not specify why two devices were required to produce sound. A "flip book" was worn on the arms of those directly involved with the field operations of Stargate devices. Within S-4, all settings for the Looking Glass were achieved from the control room so no flip books were required. This consisted of drawings and specific "galactic positioning codes" which were used to program the Stargate devices so that personnel could accurately determine their destination point once the device was in operation.

AREA S-4 SUB FLOOR LAYOUT
(LEVEL 3)

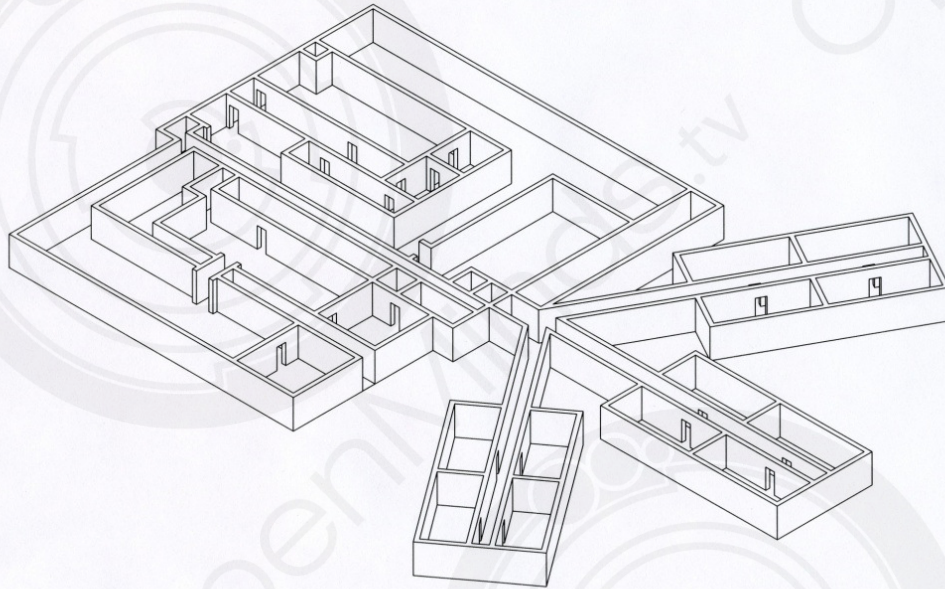

DRAWING BY MICHAEL SCHRATT 3/4/10
PER DESCRIPTION BY DAN BURISCH

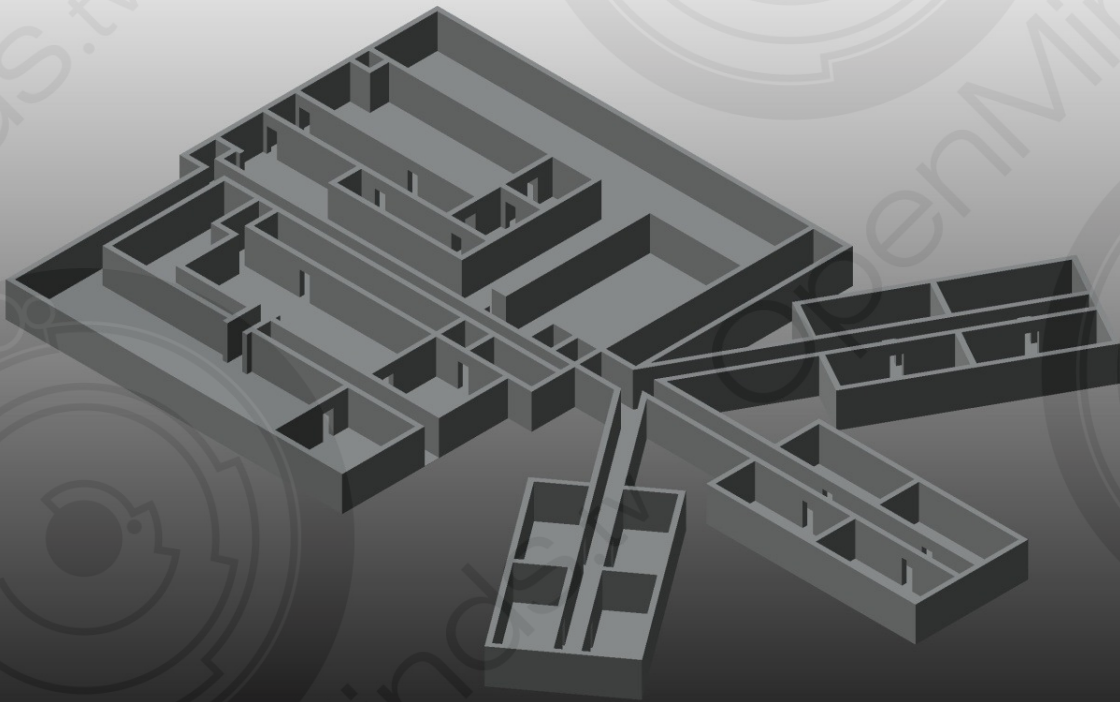

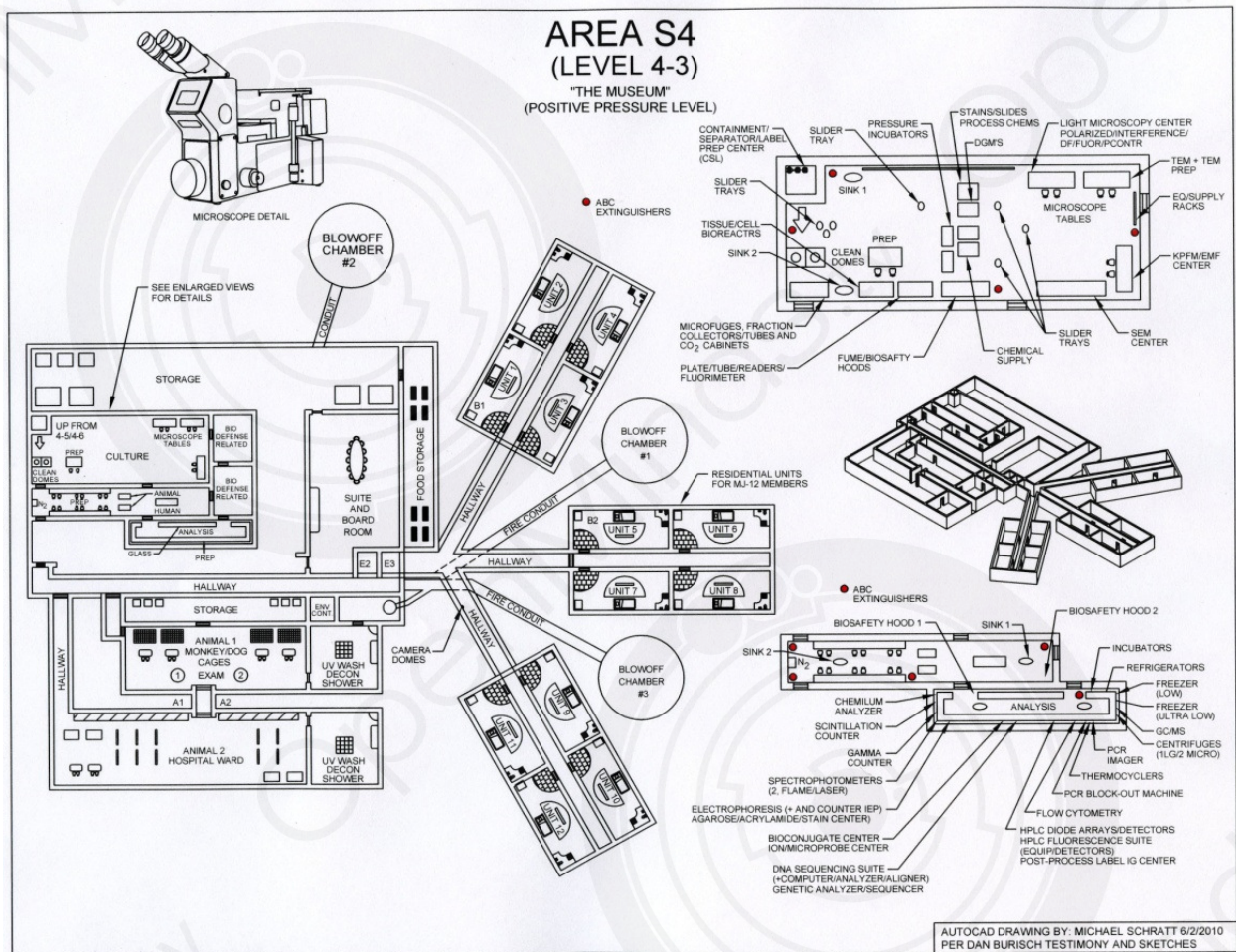

Level 3 of Area S-4 contained the residential living quarters for members of Majestic 12. Dan and I are only willing to say the following, and only that information may be represented as coming from us: “The former Leader of the Consistory of the Majestic was accurately identified by Dr. Dan in an affidavit sworn under penalty of perjury. That former leader was a high ranking official in:

- a) The United States Navy
- b) The National Security Agency (NSA)
- c) The director of National Intelligence’s Office

That former leader is properly indentified by the name: “J. McConnell”. The residential portion of this level consisted of 12 apartment-like rooms, complete with a sunken living area, television and rest room. Level 3 also contained decontamination wash stations, along with a storage facility. Additionally, level 3 contained a board room, and provisions for a fully equipped biological laboratory consisting of tissue and cell culture analysis areas, and dissection facilities.

AREA S-4 SUB FLOOR LAYOUT
(LEVEL 4)

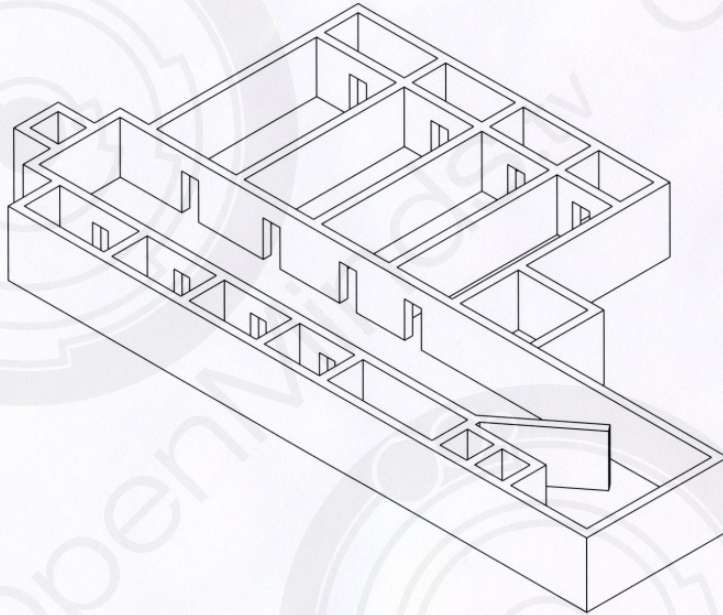

DRAWING BY: MICHAEL SCHRATT 3/4/10
PER DESCRIPTION BY DAN CRAIN

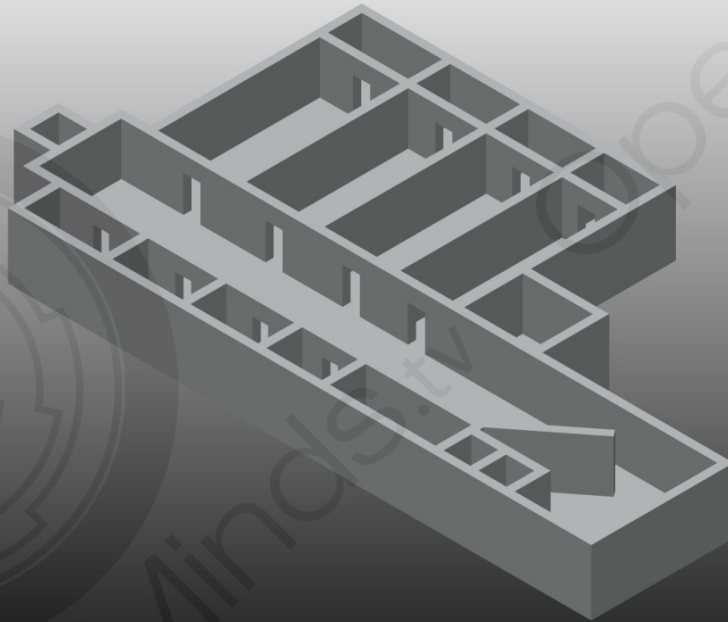

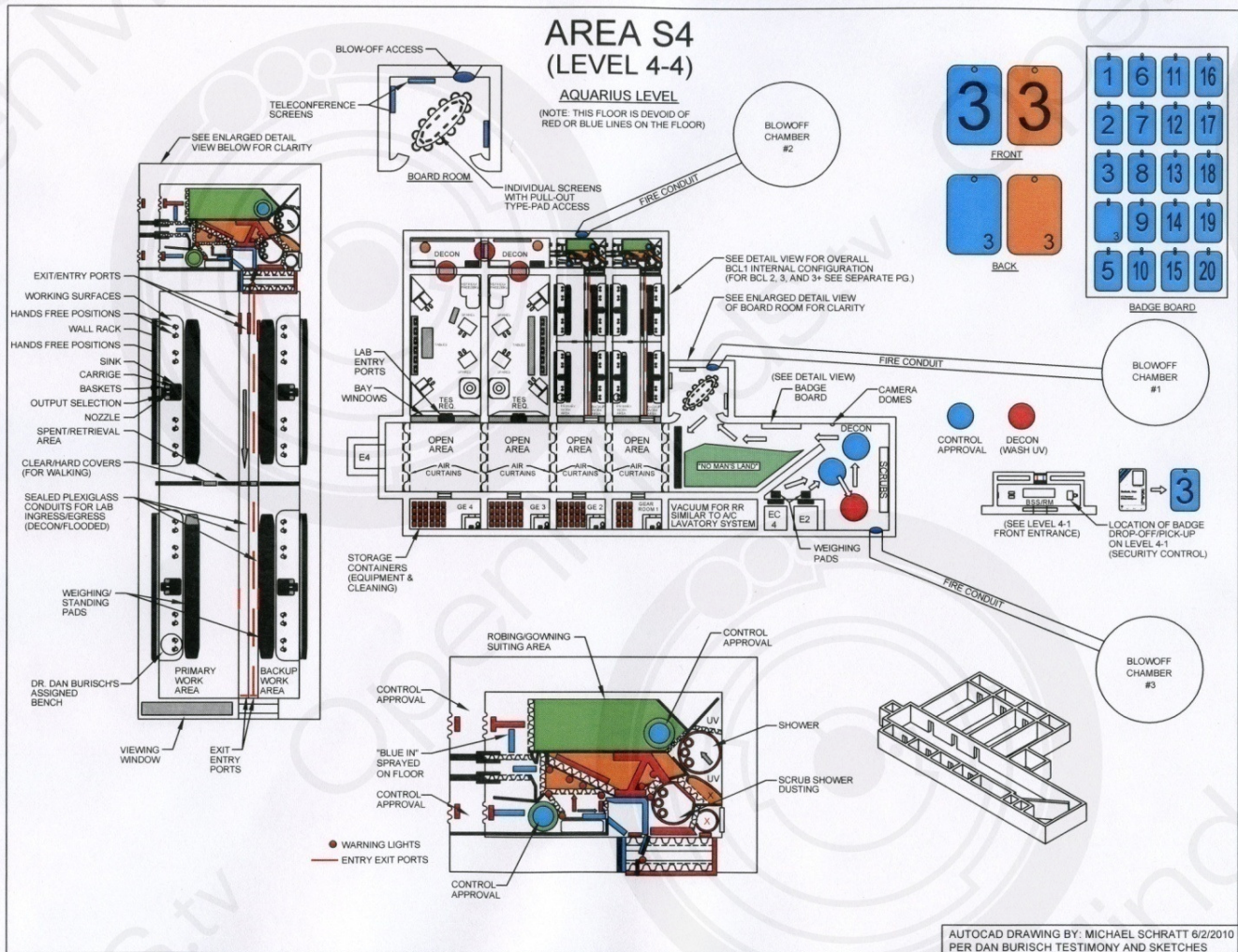

Level 4 aka the “Aquarius Level” contained five decontamination areas, along with multiple laboratories and equipment rooms. Level 4 also includes the only access elevator to Level 5. While working at Area S4, Dan’s security badge number was: H-6196MAJ. Dr. Marcia’s Majestic badge number was Q-3192MAJ. According to Dr. Dan Burisch, his boss at Area S-4 reported to the Majestic 12, who in turn reported to a cover committee who reported to the Committee of the Majority. The cover committee’s job was to condense, and sometimes prevent reports from reaching the committee of the Majority. The Committee of the Majority was an internationalized version of the group called “The Majestic” which had been started in 1947 by President Harry S. Truman following the Roswell crash. The Majestic 12 were organized after the Roswell crash, not because of extraterrestrial contact; that could have been handled with the existing infrastructure of the U.S. military, while it was being reorganized following World War II.

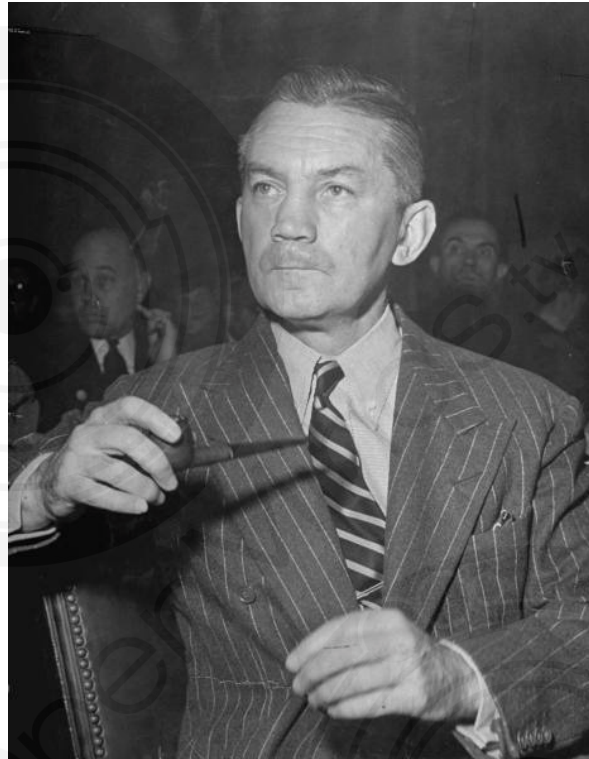

James V. Forrestal

The fortuitous time of the Roswell crash, and the recognition that we were dealing with the high strangeness of time travel, prompted President Truman to produce a group which was placed outside the normal organizational structure of the United States government. This all came together being secretly shuffled underneath the movements that were going on to establish the National Security Act of 1947. The Majestic has used that same technique ever since: diplomatically and militarily move its actions forward underneath more public actions that were going on. James Forrestal, the first Secretary of Defense, who assumed his duties at about the same time as the National Security Act of 1947 taking effect, became the de facto first leader of the Majestic 12. His private compass became the symbol for the person who should lead the group: a compass that always points to the ethical and moral right direction.

As time went by, and as the exposure of the P-45 J-Rods began spreading to countries East of the "Iron Curtain", the Majestic became aware that if it didn't embrace the Soviet Union into a unified group, the diplomatic arrangements between the P-45 J-Rods and others, could wildly spin out of Majestic's control. To prevent this, the Majestic agreed to internationalize the study and control group of the E.T. question. Thus was born "The Committee of the Majority". The Committee of the Majority was organized as a group of 33 persons of multiple nationalities with a focused group of 12 Americans underneath it, remaining under the name: "Majestic 12". The organization of the Committee of the Majority happened under presidential term of John F. Kennedy. The shuffling of information between nations and official communiqués happened along side of the creation and ratification of the partial test-ban treaty of 1963. The information leaked to Ufology that Majestic's birthday was September 24 happened because only partial information of the truth reached them. The association between September 24 and Majestic happened because the partial test-ban treaty of 1963 was ratified by the United States Senate on September 24, 1963. (In the fear that Ufologists and investigators were getting too close to the truth during the 1980's and 1990's, disenfranchised members of a former disinformation unit leaked the September 24 date, but paired it with information that was not true. That group's name is "The Aviary". The job of that group has been, and will always be to lie to you, and confuse you with truth mixed with lies).

Members of the Majestic have always embraced September 24 as its birth date because that is the date a world shaking problem was first embraced by the world, through the Committee of the Majority. The negotiations finalizing the structure and function of the Committee of the Majority were completed a few years later (in a process called chartering) during the finalization of the outer space treaty of 1967. From until 2002, the Committee of the Majority remained in control of the expanding E.T. issue. In 2002, the former head of the Majestic 12 opened a coalition to inform the world-wide of the totality of the extraterrestrial time-travel issue. He decided this as the compass for the Majestic because he believed that the people had a right to know of events that would soon come in their future, and because data from the Looking Glass units had revealed that wider public knowledge of the time-travel reality would in a partially nebulous way, somehow assist humanity in passing the time of the J-Rods and Orions historical catastrophe without such a catastrophe happening in our current time line. The resulting political ramifications rocked the Committee of the Majority, causing its near immediate collapse over the question of disclosure. Following its collapse, the former head of the Majestic 12 under The Committee of the Majority took charge of the group in schism, and reformed an internationalized version of the group of 12. By the end of 2005, as part of its founding agreement for the Majestic 12 to be handed over from one Masonic Rite to another, a vote was taken to adjourn the previous Masonic Rite's group, and to order selected operatives to provide a limited disclosure of the extraterrestrial phenomenon to the public. They followed their orders with the release of information which includes this document.

Level 4 known as the "Aquarius" level, contained the so called "badge wall". By the time one gets down to level 4, one is only wearing either an orange or a blue numbered badge. It depends on what badge one was given at Security Control. The badges, like the ones shown in this document were given up and stored at Security Control. From that moment onward, Aquarius team members wore the blue or orange numbered badges. It was flat colored, with a large number on the front, and a small identical number on the back side's bottom right. If one was Maj ECHELON, they would ALWAYS be given a blue badge with the numbers in white. At level 4 decon, the decon specialist would assign the level 4 number, from a badge board filled with more of these badges. Your original badge would be turned over, on the spot where the new number would be assigned. For the purposes of the technical Level 4-4 drawing found in this document, Dan has mocked up a board, where one person, #3 had entered Level 4, and was assigned #4 by the decon specialist, for Level 4. Once done working on the Level, Level 4's #4 would present his badge to the decon specialist, and receive his original #3 badge, back to wear, as he ascended to the S4-1. Once back at security control, he would hand his #3 badge back to security, and receive his personal badge in return. Nobody was allowed to use proper names in the facility at all.

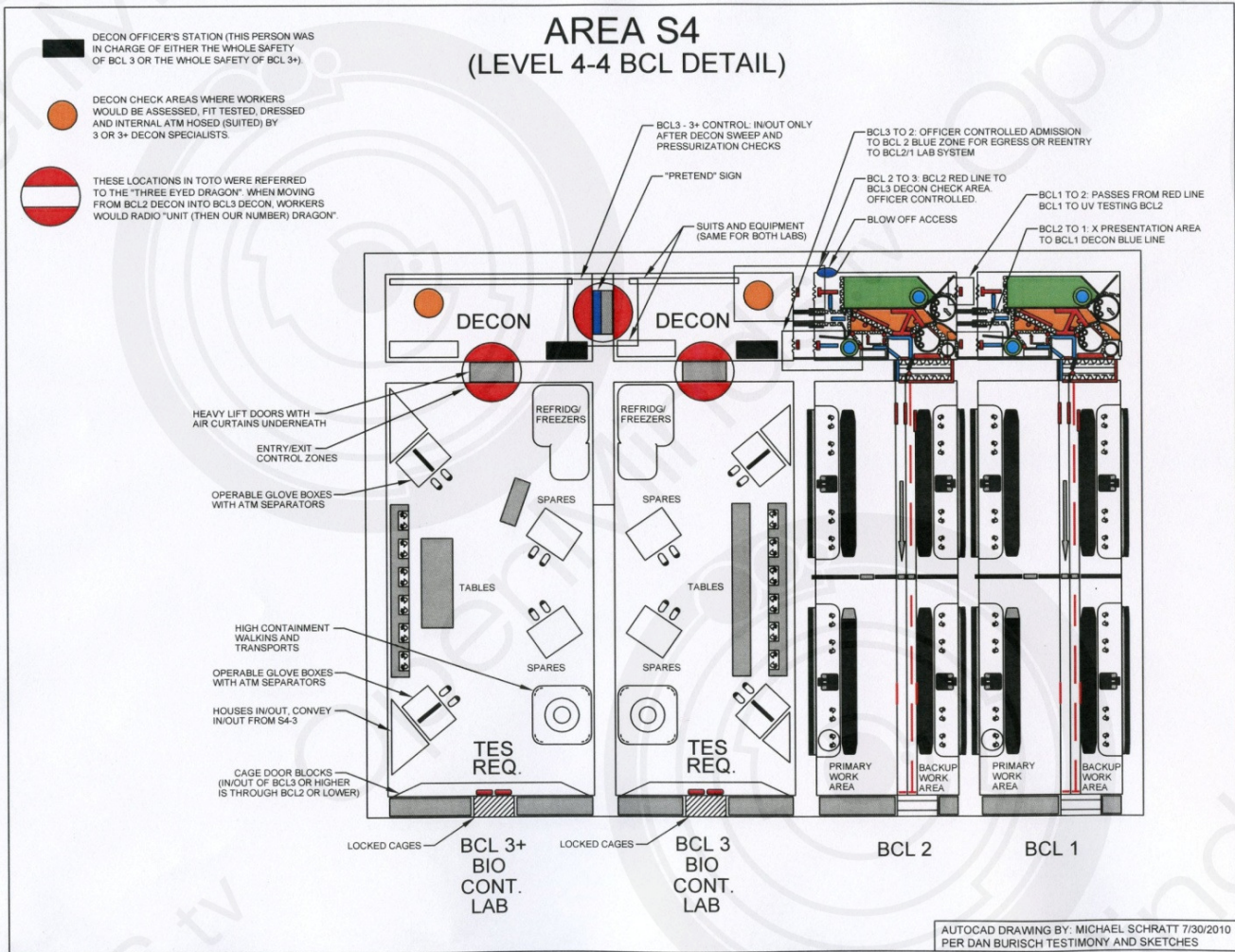

Detail view of Level 4-4 showing Bio Containment Labs.

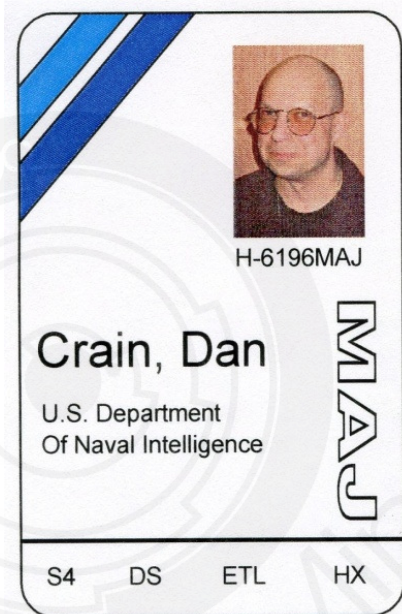

(security badge simulation)

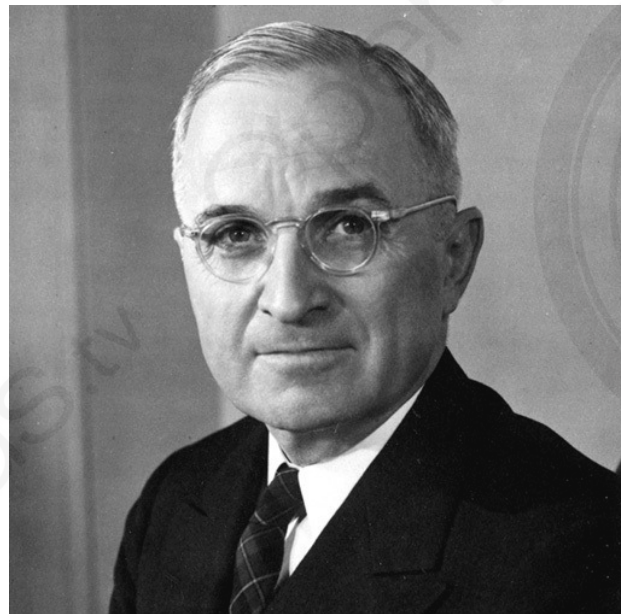

AREA S4 (LEVEL 4-5)

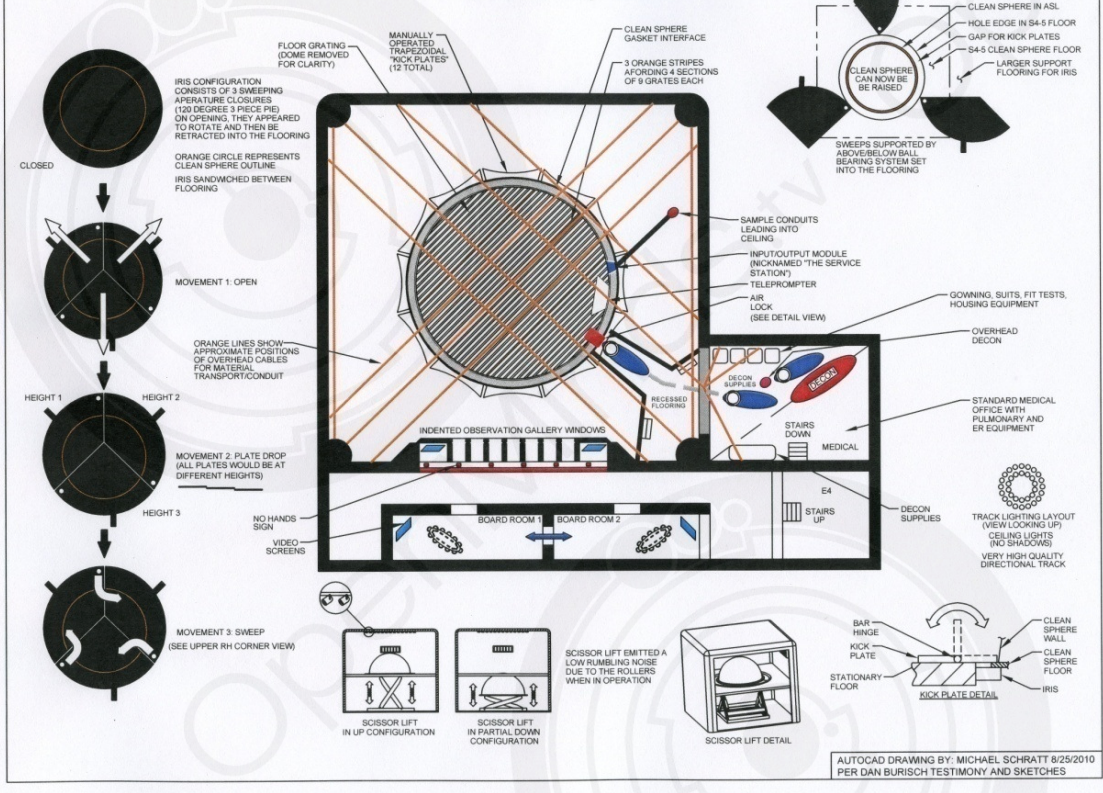

(S4-4/5 GANTRY VEHICLE AND OVERVIEW OF CLEAN SPHERE ENTRY PROTOCOLS)

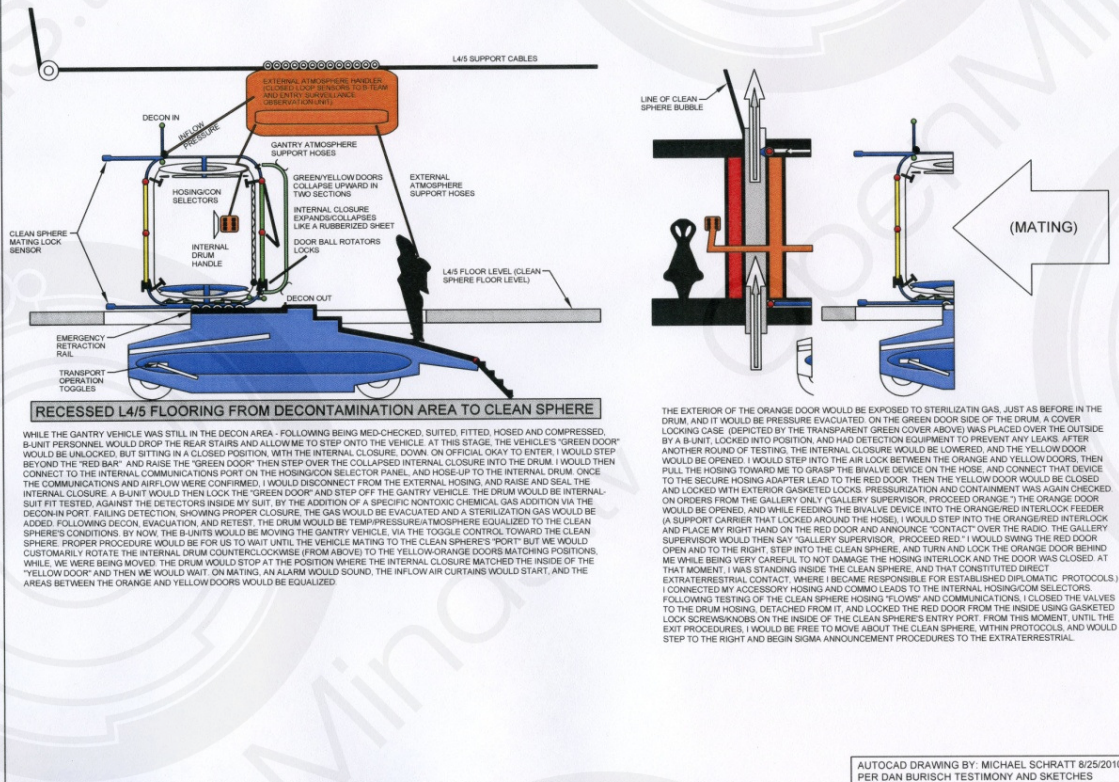

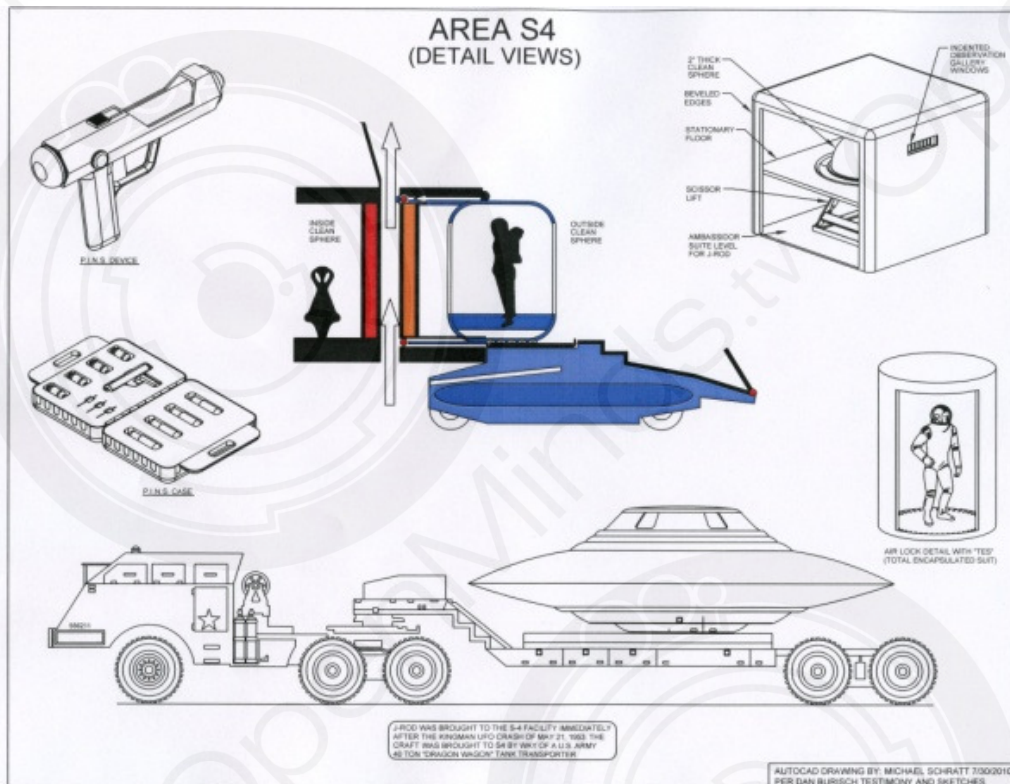

Dan's assignment at Area S-4 was to enter a set of large rotary air lock doors, and step into a clean sphere. From there, he was to take living tissue samples from the "specimen" that awaited him. The fact that there were nine hangar bays at Area S-4, and that the sum of the two numbers which made up level "4-5" equals nine is no accident. The facility was numbered in this specific fashion due to the fact that the number nine is of numerological significance to the J-Rod's culture. Eventually, Dan became the Project Aquarius working group leader, and he wrote the final report on over 200 tissue samples which were taken from the J-Rod.

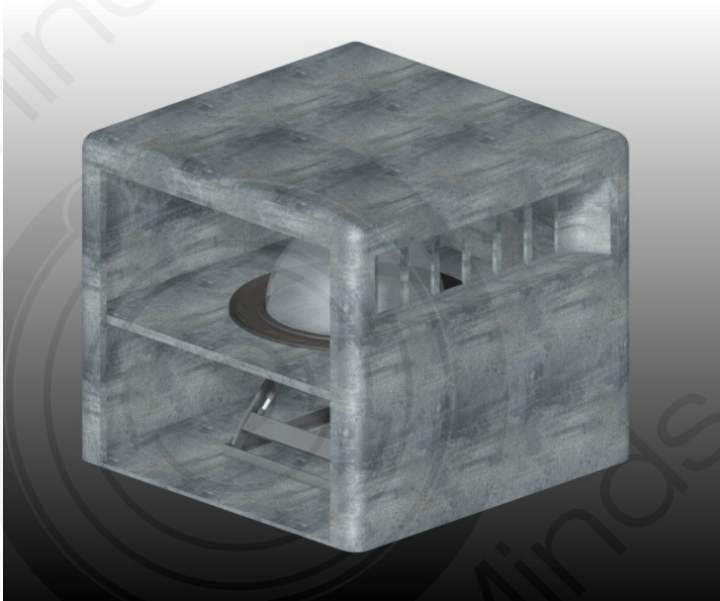

Measuring fifty-two feet seven inches across (from exterior edges of the clean sphere), and approximately twenty-six feet three inches tall, the entire clean sphere floor is about 100 feet across. The wall of the clean sphere measures two inches thick. The clear optical quartz “clean sphere” must have a represented significant engineering hurdle to install in place during construction of the facility. Special note: The clean sphere dome was NOT a complete dome or globe, but in point of fact, $\frac{1}{2}$ of a sphere (similar to an orange cut in half). The upper portion of the clean sphere housing contained exactly seven indented windows (measuring 2-1/2 wide by 4-1/2 tall), with two indented sections, one on each end of the windows containing a large screen television for camera monitoring which allowed for high level military brass and scientists to monitor Dan’s work with the J-Rod below. These included members of MJ-12 who lived inside the residential units on level 3, when visiting. All activity inside the clean sphere was recorded on video tape for the historical archives. Provisions for two board rooms were also located at level 4-5.

A large “scissor lift” was located at the bottom of the facility which could raise and lower the clean sphere. The operation of the scissor lift in the clean sphere was almost identical to the scissor lifts used at large commercial airports (see above photo). According to Dan, this scissor lift made a low frequency “rumbling” noise when in operation. An identical area of flooring led to the airlock mating system of the clean sphere. This allowed the gantry vehicle, with Dan inside a containment vessel to be driven to and locked onto the clean sphere airlock. A metal ventilation grating screen was located on the floor surface of the clean sphere. Officially, Dan was assigned to be the working group leader in Project Aquarius, R-4800, Pappoose Site-4 on the Nevada Test Site. First class impeccable lighting was used in both the clean sphere (level 4-5) and level 4 labs. The level three laboratories were also lighted and had extremely good local lighting. In the clean sphere, this lighting consisted of at least 40 high quality directional track lights which could be configured to allow for virtually no shadows. There also existed six large turret lights and multiple multi-spectrum lights as needed.

The 12 manually operated “kick plates” surrounded the circumference of the clean sphere, served to bridge the gap between the edge of the stationary floor, and the exterior wall of the clean sphere. According to Dan, these plates would slam down with a loud bang once turned over. The iris served to stabilize the clean sphere once it was lifted to the level of the stationary floor. This device was actually embedded inside the stationary floor, and consisted of only three plates which would each be lowered to an individual level, then swung outward and away from each other and into the stationary flooring. When closed, it looked like a pie consisting of three large pieces.

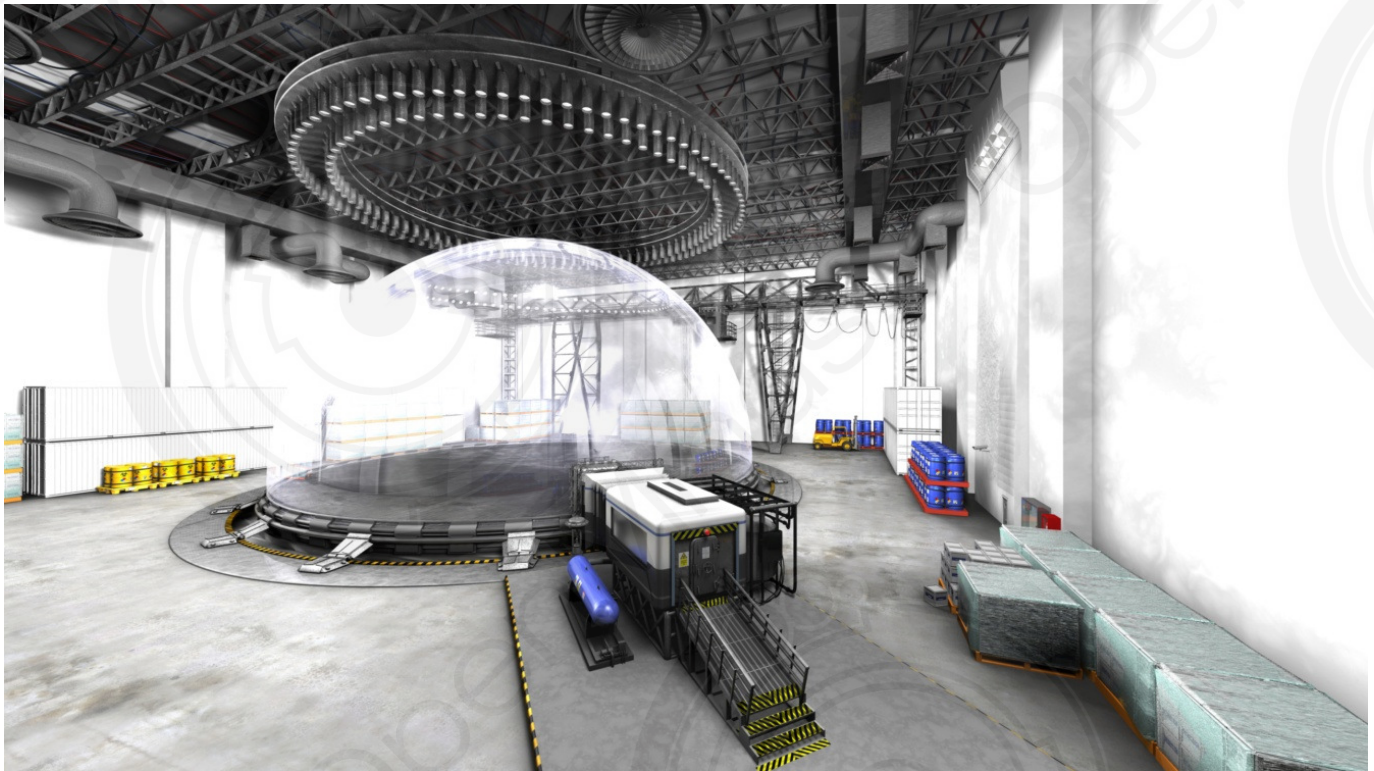

View of the Clean Sphere from the perspective of the upper floor of Level 4-5.*

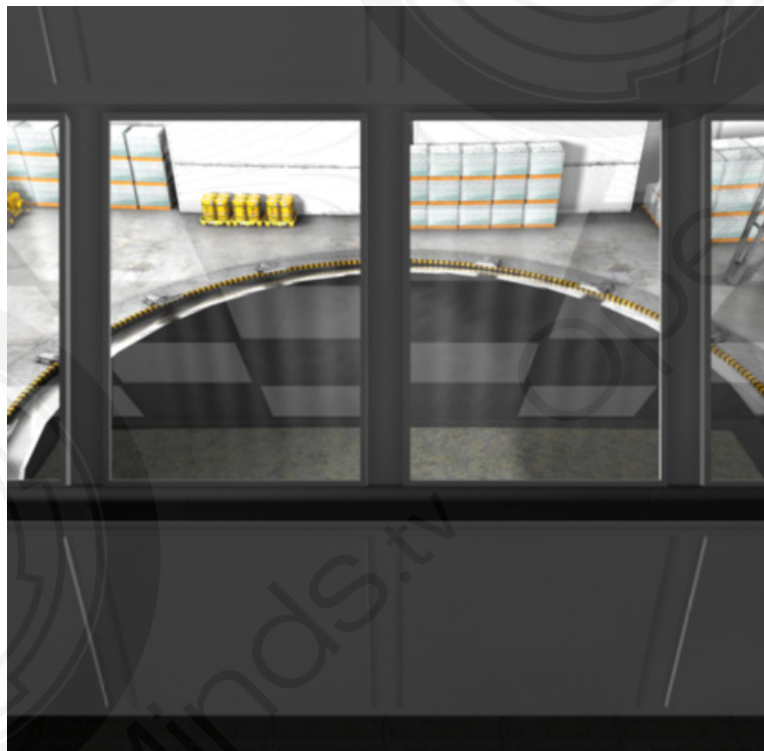

View of the Clean Sphere looking through the MJ-12 observation gallery bay windows.*

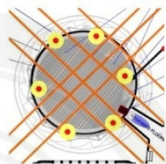
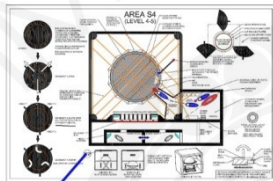

THE NICKNAME FOR THE 6 MAIN MULTISPEC LIGHTS ABOVE THE CLEANSPHERE WAS THE "BEEHIVES"! EACH TRIPLE "BEEHIVE TURRET" WAS NUMBERED (1-6). THEY WERE POSITIONED IN A HEXAGRAM, OVER AND AROUND THE CLEANSPHERE. THEY WERE EXTENDED DOWN FROM THE CEILING, AND LOWER THAN THE ORANGE/SUPPORT GUIDE WIRES, WHEN THE CLEANSPHERE WAS RAISED. THE ORANGE/SUPPORT GUIDE WIRES, WERE ALSO USED WITH TRANSITS FOR AUXILIARY LIGHTS. ALL TURRETS WERE ABLE TO BE ROTATED, & LIGHTS FULLY EMISSION ADJUSTED.

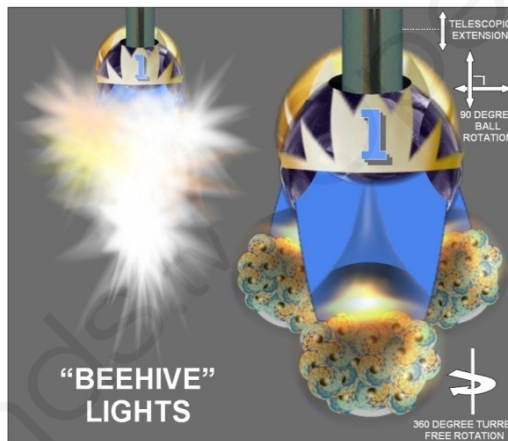

CEILING MOUNTS

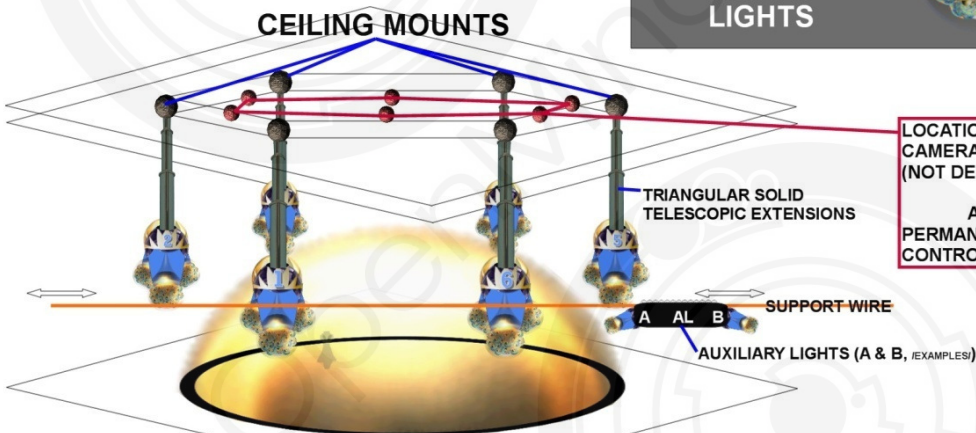

LOCATION OF CEILING DYNAMIC CAMERA/AUDIO SYSTEM (NOT DEPICTED IN THIS IMAGE.)

ALSO NOT IMAGED: PERMANENT WALL CAMS AND CONTROLLED SNAKING CAMS



THE PIN-HOLE (TRACK LIGHTING) LIKE LAMPS DEPICTED TO THE LEFT, AND IN THE 3D CEILING IMAGE OF THE CLEAN SPHERE AREA, ARE NOT COMPLETELY OFF, IN FACT THE MORE "OVAL" AREA IN WHICH THEY REALLY SET, ABOVE THE CLEAN SPHERE, IS PRETTY CLOSE TO THE 3D ARTIST'S DEPICTION. THE ACTUAL AREA WOULD SIT WITHIN THE RED CENTRAL HEXAGON, ABOVE (DISTORTED DUE TO THE PERSPECTIVE), AND CONTAINS SMALL TRACK LIGHTS THAT LOOK MORE CLOSELY TO THE IMAGE JUST BELOW. THE TRACK LIGHTS ARE SEPARATE FROM THE BEEHIVE LIGHTS, BOTH THE LARGE TURRET 'KIND,' AND THE SUPPORT WIRE 'KIND.' THE TRACK LIGHTS ARE ENOUGH TO FILL LIGHT THE CLEAN SPHERE FLOOR, BUT THE TURRET LIGHTS DO A ONE-OF-A-KIND JOB. THE TURRET LIGHTS WERE DESIGNED BY THE J-RODS, AND BUILT BY S4 ENGINEERS.

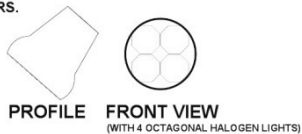

Detail of lighting configuration above the clean sphere per Dr. Dan Burisch

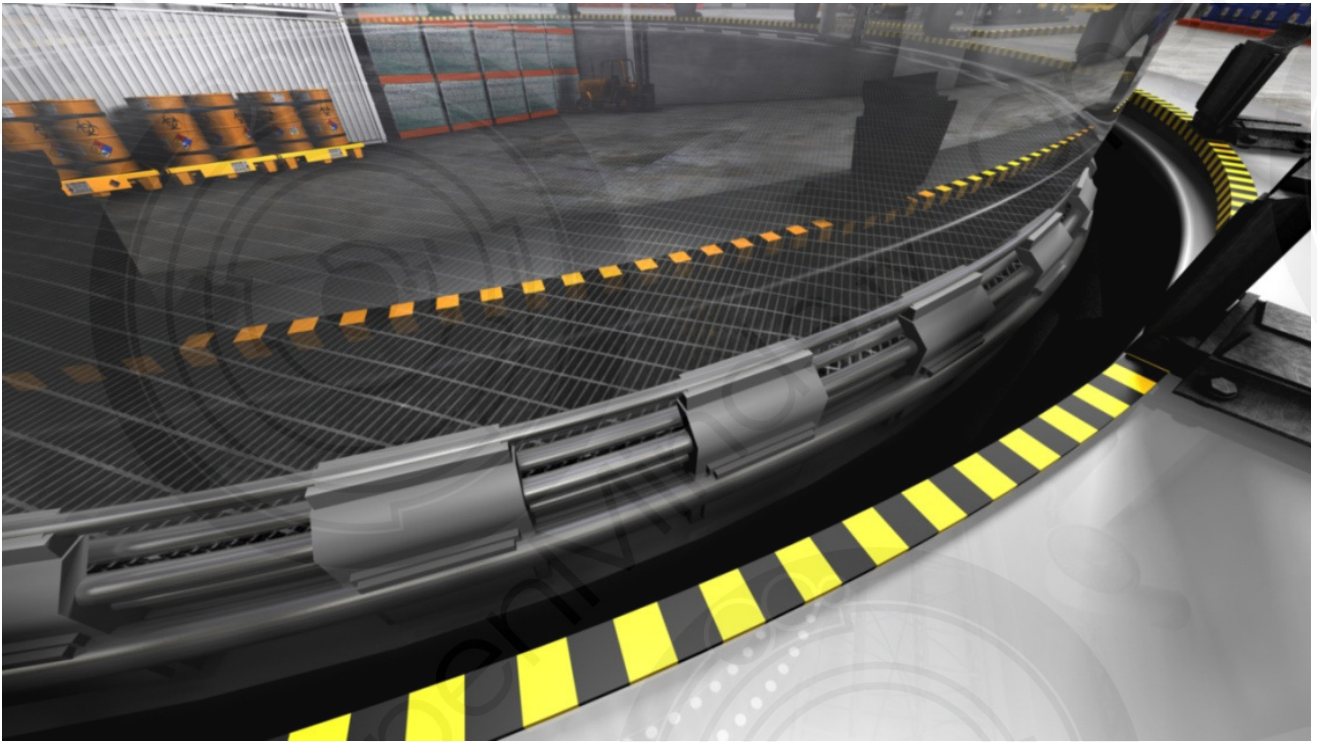

View of Clean Sphere showing gap between CS wall and upper floor.*



View showing retractable iris in upper floor and kick plates.* (According to Dr. Dan Burisch, these kick plates were turned over manually)

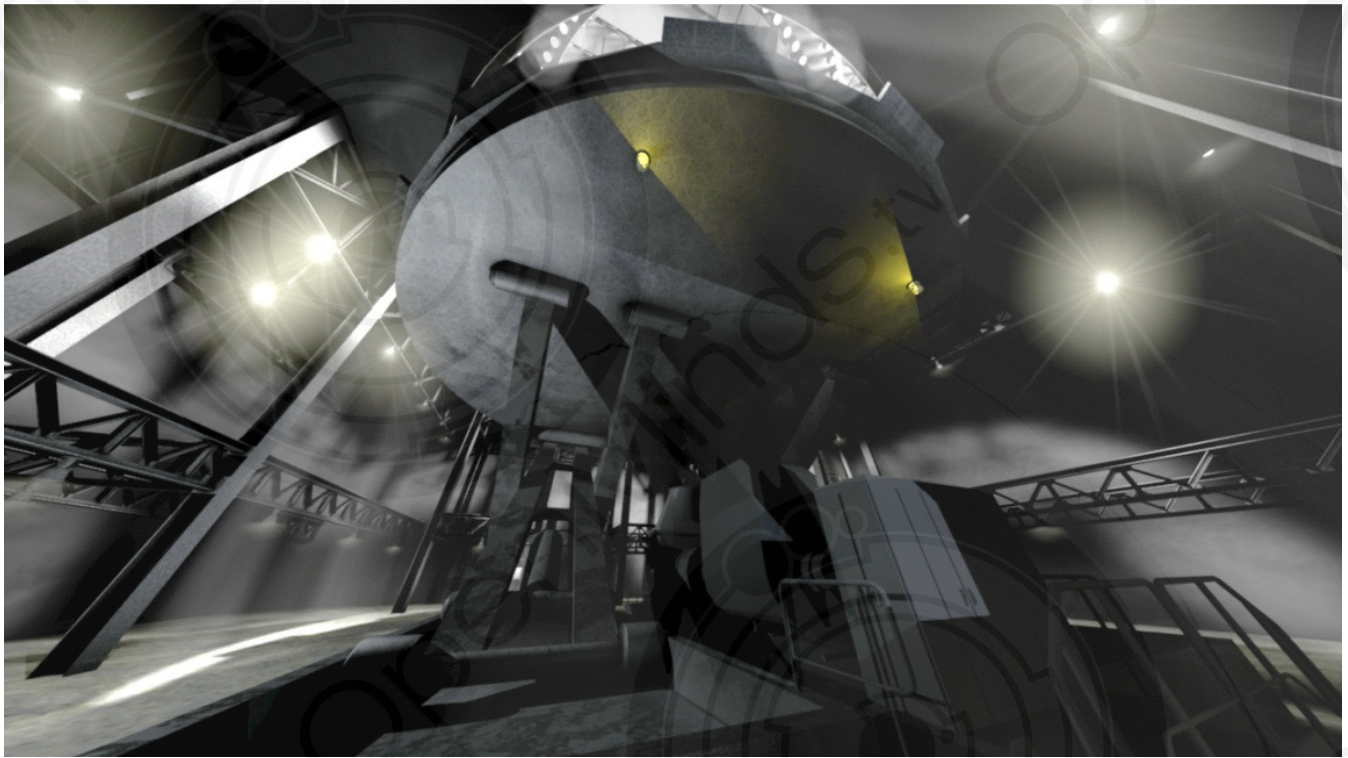

View showing lower floor of level 4-5 with Clean Sphere scissor lift during “UP” extension.*

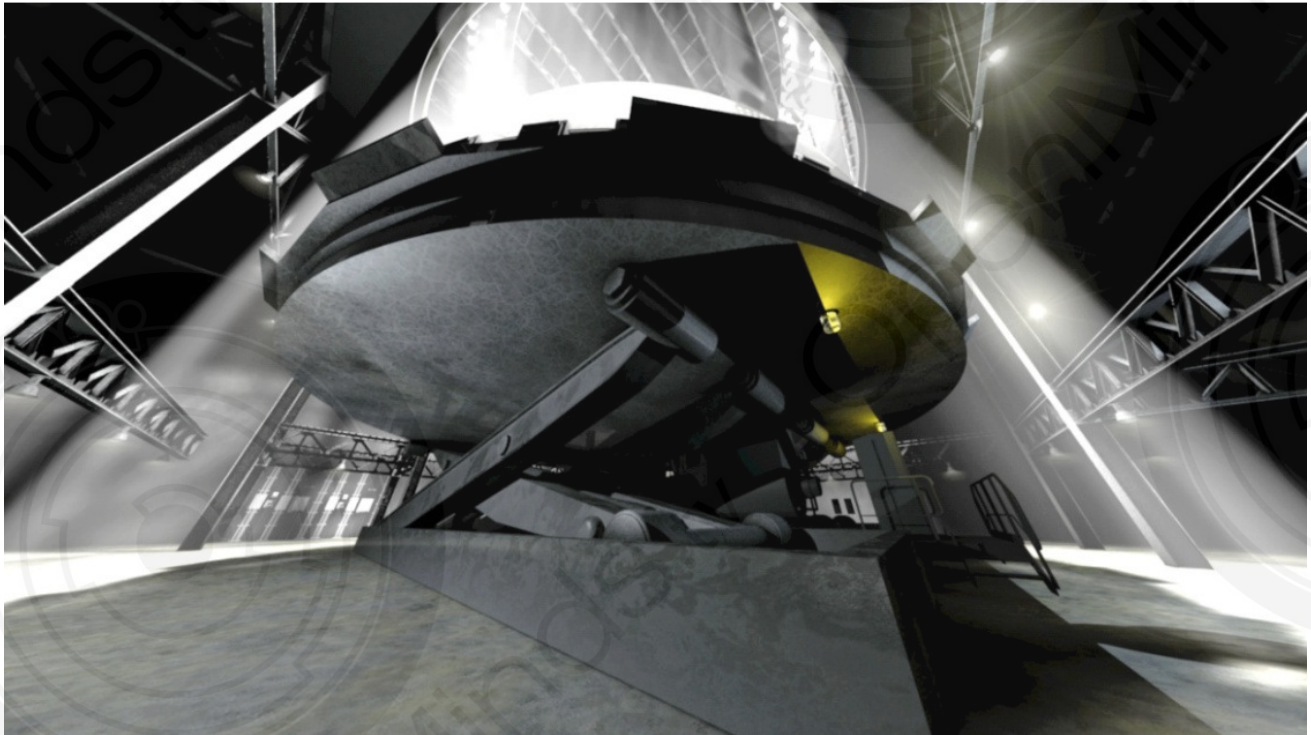

View showing lower level 4-5 with Clean Sphere scissor lift during partial “DOWN” retraction.*



Before meeting the J-Rod, an extensive series of precautions had to be made. This included wearing a Totally Enclosed Suit (TES), similar to an astronaut's space suit. The TES included a long umbilical hose system for oxygen and air conditioning. This provided a "positive pressure" closed system environment inside the suit, which would protect Dan from any potential microbes or viruses during contact with the J-Rod.

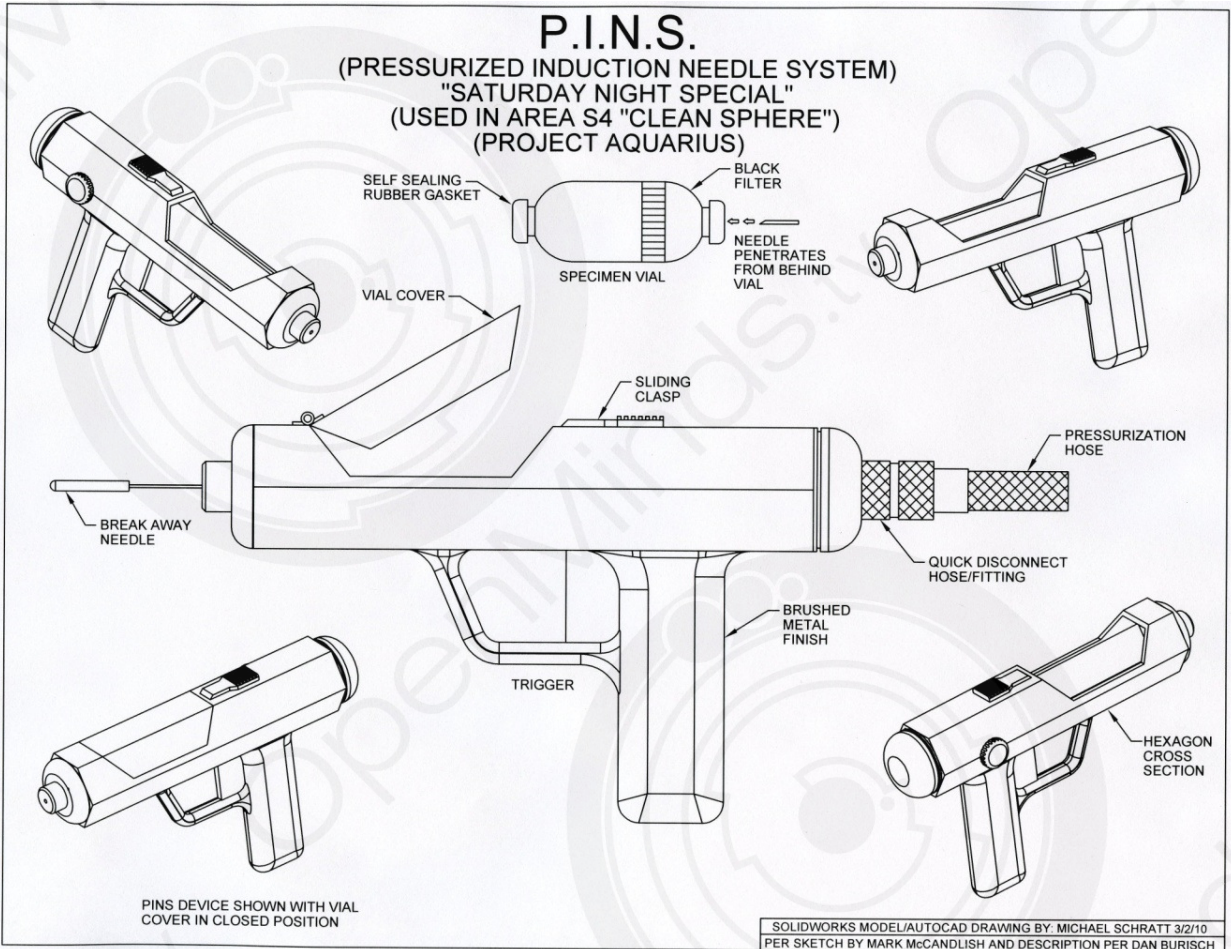

(Note line drawing, and two illustrations of the P.I.N.S. device showing showing hexigon type cross section). Per Dan's description of the P.I.N.S. device, he referred to it as a "Saturday Night Special", indicating its small size.

The P.I.N.S. (Pressurized Induction Needle System) device was specifically designed for taking biological tissue samples. The device had a brushed metal exterior finish, similar in appearance to modern medical equipment. During operations inside the clean sphere, a pressurization hose was attached to the aft end of the P.I.N.S. device. Next, a small specimen vial was loaded into the empty chamber. A sliding spring loaded clasp located on the top section of the device secured the top cover in place. A small rotatable “on/off” valve was located on the right side of this unique medical device. The PINS needle would be inserted into the correct location inside the body of the living J-Rod. This procedure was performed without the J-Rod either receiving a local anesthesia or sedation of any kind.

This caused great pain for both the J-Rod and Dr. Dan who was taking the sample, as Dr. Dan was entrained by the J-Rod and he was feeling the J-Rod’s pain in the corresponding location of his own body. This occurred for each and every sample removed. After pulling the trigger-like device on the PINS unit, a specifically sized sample from the body of the J-Rod would be drawn into the pressurized vial of the PINS unit. Each sample was extremely small. The needle would be withdrawn from the body of the J-Rod. The side valve of the PINS unit would be turned to a closed position, and the PINS unit would be placed into the case for the PINS equipment, onto a specifically indented area of hardened foam. Pressure, with use of a specific pressure patch would then be applied to the area of the J-Rod where the needle had been inserted. The pressure would be held constant against the J-Rod’s body for at least fifteen minutes.

At the conclusion of the session, Dr. Dan would be instructed to remove the patch and assess the area for any swelling or liquid emissions. If the J-Rod was bleeding, further steps would be taken for his care. If the J-Rod was not bleeding, the pressure patch would be inserted into a small vial within Dan’s PINS equipment case. Next, the vial in the PINS unit would be removed from the unit. Both vials would then be carried across the clean sphere to the export transit system located on the equipment service station near the clean sphere’s teleprompter. A port leading up to level-3 was chosen and announced by Dan over the radio. Pressure to that port was turned off by level-3 culture personnel and Dan was informed when he could unlatch the port cover.

On being told he could open the port cover, Dan indicated what he was doing over the radio, then rotated the port cover 90 degrees counter-clockwise and pushed the port cover inward, which then caused the entire port to slide out toward him. The port looked like a cylinder, about the size of a roll of U.S. quarters. The left side of the port had an oval opening. The vial containing the pressure patch was inserted into the port first, and then was pushed forward into the port with Dan’s gloved left thumb. After pushing the vial containing the pressure patch forward, the vial containing the tissue specimen was placed into the oval of the port directly behind the vial containing the pressure patch. Using his right hand, he clasped the cover of the port, and pushed the port forward, back into the service station’s frame. He then pushed the port inward, and rotated it 90 degrees clockwise, causing it to latch closed.

He would then pick up a smaller glass cylinder from the floor of the clean sphere, below the service station, which was sitting on the floor, propped up between two grates near the inside wall of the clean sphere. (This was added by other personnel and remained there on the floor between uses.) The cylinder had a locking mechanism. The open end of the cylinder was inserted into a locking ring which circled the closed port. Dan would press inward and rotate the cylinder 90 degrees clockwise to lock the cylinder forming a cap over the port. Level three lab personnel would be informed by laboratory surveillance that the port was locked, and would instruct Dan to take one step backward away from the port, following which they would pressurize the system and suck the two vials up from level 4-5 to the lab on level 3 in a manner reminiscent of a drive-thru banking pneumatic tube system. After successful receipt of the tubes on level 3, Dan would be instructed to remove the sample port's cylinder cap by unlatching it with a 90 degree counter-clockwise turn, and place it back on to the floor from where he first took it. Following this, he was free to return to the J-Rod for further work.



Illustration of P.I.N.S. case

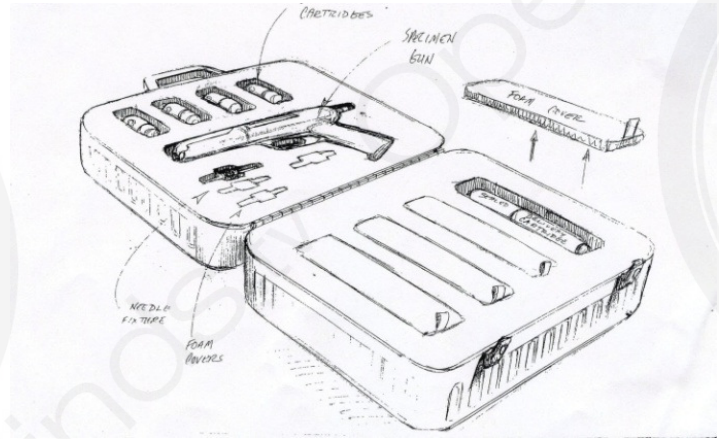
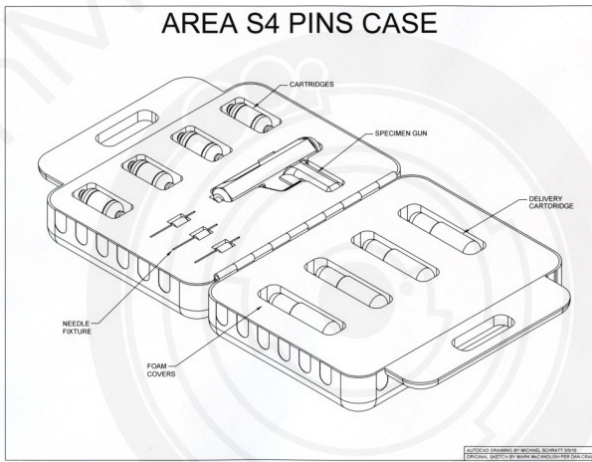

Dan described using a specially configured brief case to carry the P.I.N.S. device with him into the clean sphere. The case had a metallic exterior finish, with a fully integrated handle. The interior of the case was lined with black foam. The P.I.N.S. device was stored in a conformal cut-section of the foam, with provisions for at least 4 specimen vials, and up to 12 break away needles.

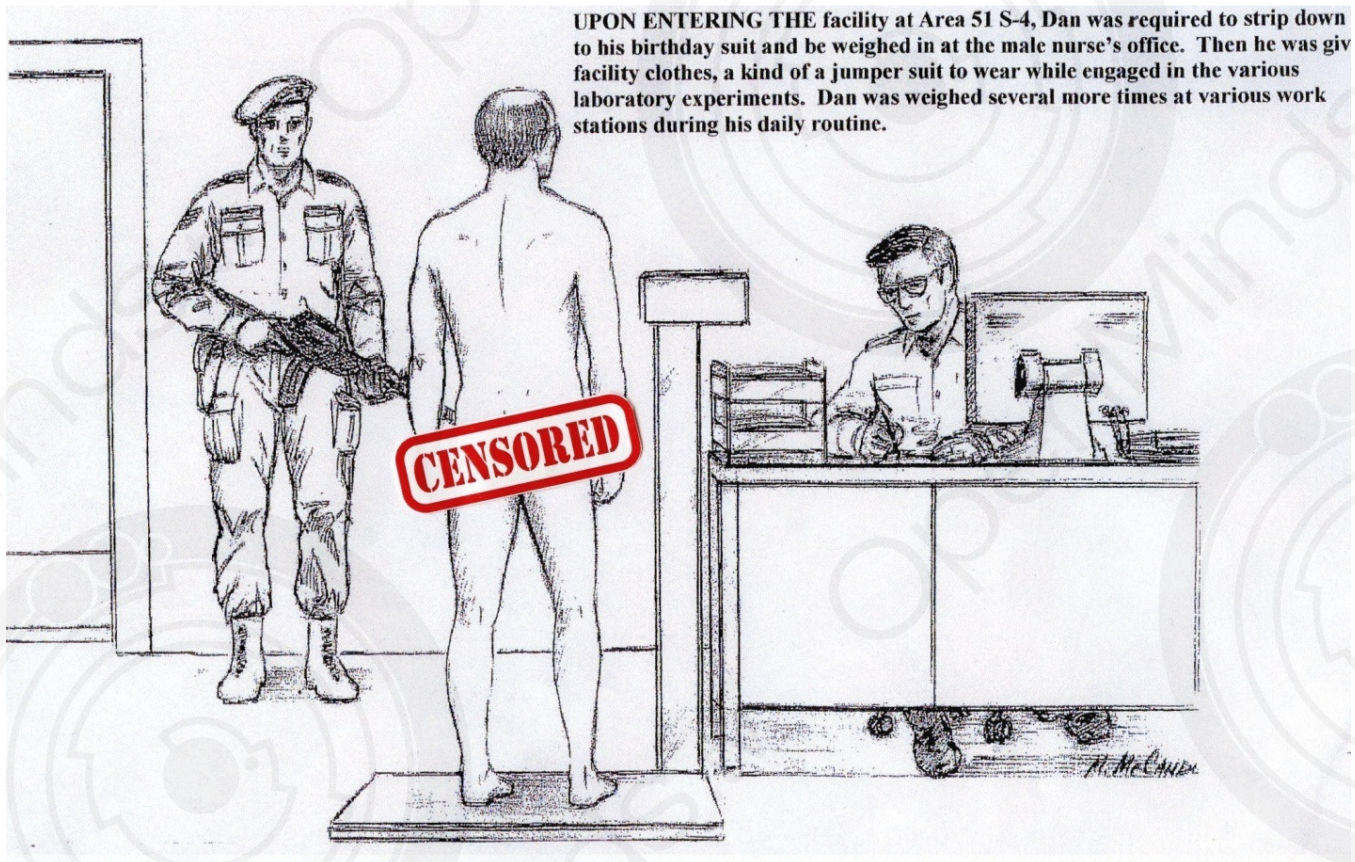

UPON ENTERING THE facility at Area 51 S-4, Dan was required to strip down to his birthday suit and be weighed in at the male nurse's office. Then he was given facility clothes, a kind of a jumper suit to wear while engaged in the various laboratory experiments. Dan was weighed several more times at various work stations during his daily routine.

Sketch depicting weighing pad.*

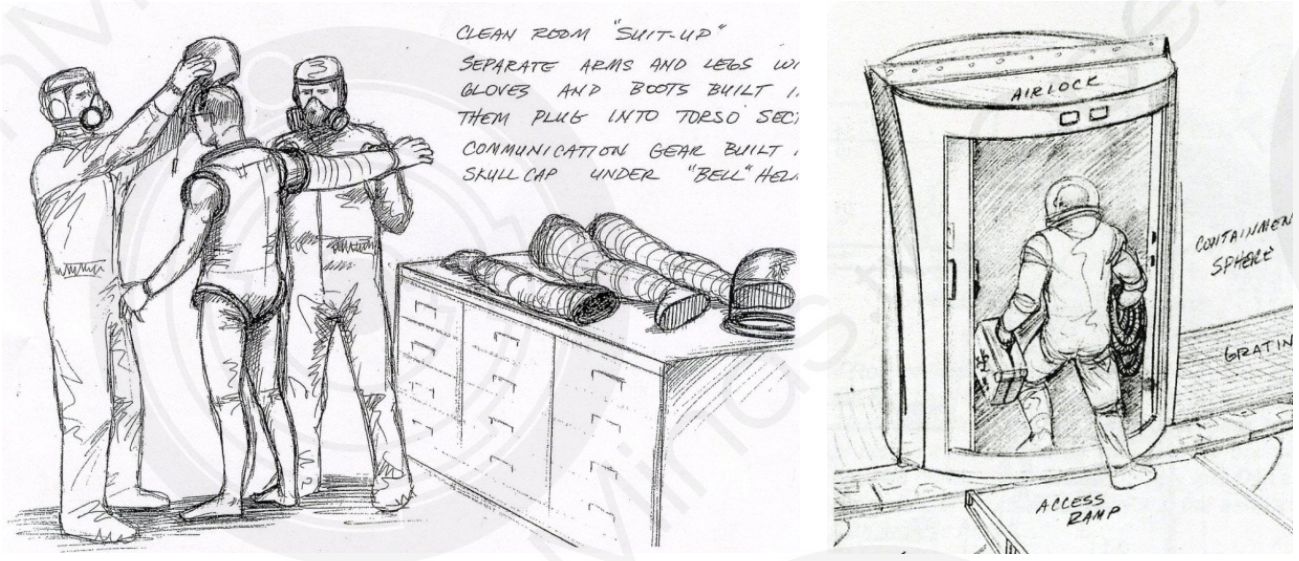

Sketches depicting the suit up procedure for the TES, air-lock entry.*

Before entering the facility, Dan was weighed in the nude. This security measure was designed to ensure that nothing ever left the facility. Prior to entering the clean sphere, support personnel assisted Dan with putting on his TES. To enter the clean sphere, Dan would gather his P.I.N.S. brief case, along with the extra length of the umbilical oxygen hose, which already had been connected to the atmosphere support system. That support system was pulled along via guide wires which were stretched to various locations and wall-to-wall on the clean sphere floor level. Next, he would enter a rotatable air lock system that pressurized the chamber to match the ambient pressure of the clean sphere. The procedure for the entrance to the clean sphere is detailed on the image which shows the gantry vehicle – airlock device.



Dan was made aware that stored at Area-S4, a particular device is kept which is known as the “Orion Cube”. The device which arrived in 1954, was later nick-named “The Yellow Book” due to a yellowish vorticular color which would emanate from the top of the device upon activation. The name Yellow Book was also leaked to UFOlogy by Aviary personnel for disinformation purposes. This device in point of fact is a special type of holographic record and quantum viewing unit that both documents our history as well as presents future occurrence probabilities. It’s output is susceptible to changes unintentionally provided to it, by it’s users. Only P-52K J-Rods and Orions, and those who have been trained by such J-Rods and Orions through entrainment can operate the device without substantially altering its output. The Looking Glass device as described from the S 4-2 Level does not suffer this potential shortcoming. Some of those who have accessed specific details regarding future events contained in the “Orion Cube” have been totally devastated by the implications.

Most of those cases of negative outcome were caused because the operator was neither a P-52K J-Rod or Orion, or a person trained through entrainment by them. The negative outcomes were largely the result of the operator himself/herself coloring the output data through their own internal fears, hopes for the future, attachments to their understanding of the past, and rigid world and philosophical views. Trained operators have either largely had few negative outcomes or have even been able to intentionally color the outcomes in a way to manipulate onlookers. The last was such a case during the Tau 9-6 treaty negotiations in the 2003-2004 time period. The P-45K J-Rods were successfully talked out of treaty authorized present human abductions (terrestrial abductions) by the use of a ruse involving the Orion Cube. This device was given to President Eisenhower at Edwards AFB during a pre-arranged meeting with the P52 extraterrestrial “Orions” in 1954 when an official treaty was brokered for later discussions and formal signings. Of special note is the fact that this historical event was completely captured on motion picture film reels. The cube measures 8 inches square, and projects a holographic image above a 10 inch diameter emitted disc of concentrated light. The cube has been stored at multiple locations, including Area S-4, and inside a locked vault associated with the Scottish Rite Masonic temple in Washington DC.



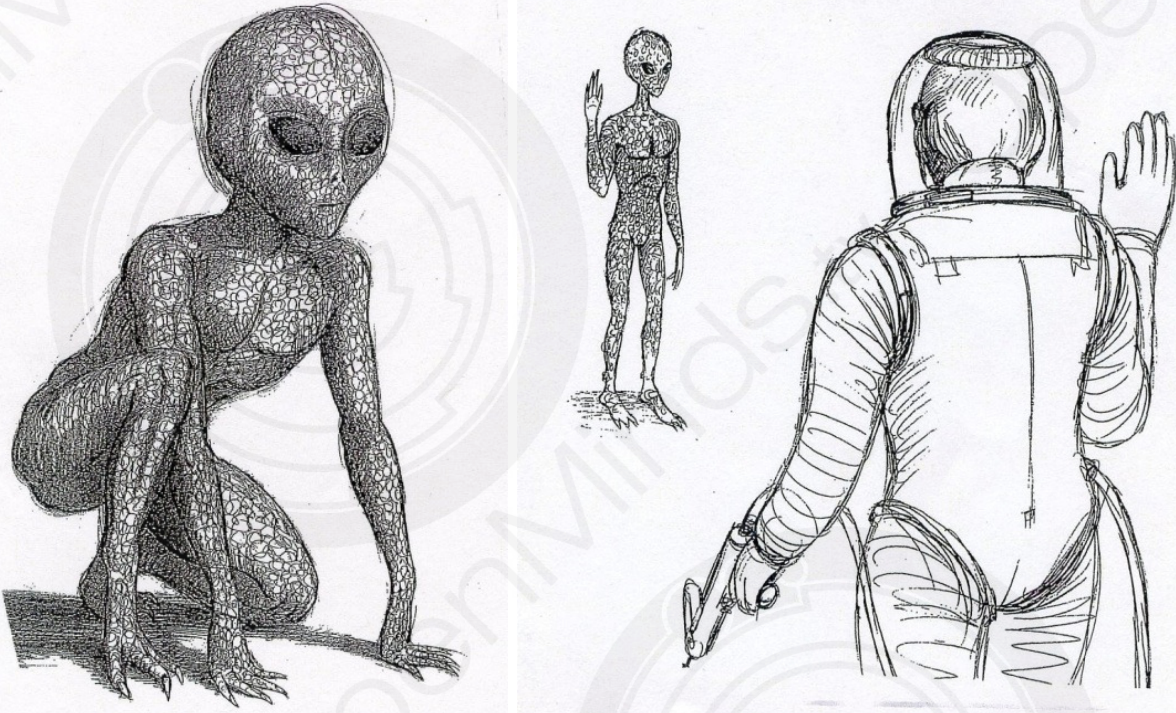

Illustrations of the J-Rod and greeting hand signal protocols used when entering the Clean Sphere.*

The first Day that Dan met what came to be called “J-Rod” by his handlers was a significant day which he would never forget. The name J-Rod emerged many years earlier when the being pointed at the J on a lighted teleprompter screen which contained the letters of the English alphabet, and at a physics inertial bar symbol on another portion of that same teleprompter screen. Telepathically, the being communicated that those symbols were summed as an identification of himself. The J’s 10th position in the English Alphabet and Sigma Units (language unit) relating the inertial bar to the Mayan glyph for the number 5 indicated that “JRod” stood for the number 15. Fifteen being significant, due to the fact that it was his applied designator for the number of light years from earth to a base from which the P-45K J-Rods travelled to earth for their work with present-day human kind. As a specially trained (and specially appearing) P-52K J-Rod he was integrated into that base for diplomatic efforts on the part of the P-52K J-Rods, with the P-52K Orions. The base was located in the Gliese System, in the direction of the constellation Aquarius, the origin of the name of the project “Project Aquarius”. Upon observing the J-Rod for the first time from the gallery, after he and others had worked on the J-Rod’s tissues and cells, for a few years without ever being directly told they were working on extraterrestrial material, he was shocked at the appearance of the J-Rod.

While sitting within the clean sphere, the J-Rod reminded Dan of a small, darkened, hunched insect like creature. Following being briefed on the J-Rod’s origins and other known aspects the team in which Dan served returned to their laboratory work on the extraterrestrial material. During this time Dan and his fellow team members internally wrestled with the fact that there existed an extraterrestrial intelligence (in fact a few of them) which were directly related to human kind. Their mere existence in our general time period as time travelers, constituted a paradox that they also learned had been codified as a doctrine. Amid fear, excitement, and complete astonishment, they realized and were shown the documentary and historic proof that the paradoxical aspect of time travel and the data from it which revealed past historical facts different from the accepted recorded history and many future probable events was the core, the one deep truth, as to why the governments of the world have kept the extraterrestrial presence a secret from the vast populations of humanity. (Neither Drs Dan nor Marci have ever said that non-human lineage extraterrestrials –true aliens- were not

visiting members of humanity, and other life forms on planet Earth. They have said, however, that the governments of the world have restricted knowledge of their involvement with extraterrestrials due to the above stated facts involving time travel and paradoxes. Their relationship to the central players involving the cover-up disallows the attempts being made by certain disinformation specialists, experiencers, and belief advocates within UFOlogy in their attempts to hedge or add to the real nature of the governments' involvement with the extraterrestrial cover-up. Disinformation specialists + experiencers + belief advocates DO NOT EQUAL the weight of the testimony of those coming from the center of the cover-up itself.

Many have attempted to merge their testimony into the testimony provided by Drs Dan and Marci. In some cases, the salient aspects of the testimonies of others have closely matched the testimony of Drs Dan and Marci. In other cases, the testimony of others has been completely different than the testimony of Drs. Dan and Marci. In some of those cases where there is a difference, the perception of the individual providing the testimony has been skewed by the conditions or stress surrounding the event itself. In other cases, the person's testimony directly relates to experiences which have nothing to do with the testimony of Drs. Dan and Marci relating to human lineage extraterrestrials, and government involvement. In some cases individuals have applied their belief system about the extraterrestrial issue as a reason to denounce the truthful disclosure that Drs. Dan and Marci have made. In still other cases, disinformation specialists, paid to attempt to disrupt any disclosure of truthful information to the people, have attacked the testimony of Drs. Dan and Marci out of what they consider to be their professional obligations. Drs. Dan and Marci are representatives of the Secret Government itself. That Secret Government, as an entity, has heard the call of the people, pleading for Disclosure.

The very fact of the continued presence of Drs Dan and Marci before the public, plus their testimony concerning the core issues of the governmental cover-up constitutes (in and of itself) the first formal steps of world-wide Disclosure. The reactions of those who interact with the testimony of Drs. Dan and Marci are being compiled, and will be addressed as the next formal step following the original Brookings Institution study as to whether the world wide public both bears the internal fortitude and wide mental preparation for the continued disclosure of information that will affect every aspect of human culture. Should the wrong steps be taken and wider Disclosure be provided when the population is not sufficiently prepared for such potentially, wholly disruptive facts, the results (in and of themselves) have already been assessed as likely politically and culturally catastrophic. Are you prepared? Time will tell.

Soon after Dan's team was introduced to the fact that they were dealing with extraterrestrial tissue the previous unit (that had been dealing directly with the extraterrestrial - called AQJR1) was cycled – out of Project Aquarius and the team in which Dan was assigned was cycled into direct interaction with the J-Rod. The team in which Dan was assigned was designated AQJR2. At the start of AQJR2 Dan was assigned as a B-unit assisting the entry person (the A-unit) with his preparations for entry into the clean sphere. That person's name was Dr. Steven M. Soon after, Dan was ordered to replace Dr. Steven M. as the entry person (the A-unit, also called the working group leader). This brought Dan into direct contact with the extraterrestrial albeit he had been having private discussions with the extraterrestrial from the time he had first walked on to the floor surrounding the clean sphere.

Over the next two years, Dan developed a close friendship with the J-Rod. Dan would come to have confirmed by the J-Rod that his friend originated from the star group known to us as the Zeta Reticuli cluster. The being was small in stature (approximately 3-1/2 feet tall), dark brown appearance, with very large black eyes, and a disproportionately large head with respect to the rest of his body. There was a large "knob" near the being's heels on his feet. The being also had long arms, with four long fingers. His nose was significantly recessed into his head, and he had a very small mouth with no teeth. From the instant of his stepping onto the floor outside of the clean sphere, Dan had telepathic contact with the J-Rod, a contact initiated by the J-Rod. The J-Rod confirmed to Dan that his species suffered from a serious neuropathy which is an inherited

congenital condition. This condition caused a significant loss of body heat, and made it difficult for the being to stand up straight or walk. The being was never allowed to wear any clothing while inside the clean sphere. The protocols of approaching the J-Rod in the clean sphere required both to display an open hand before any tissue samples were taken. During his time with the J-Rod at S-4, Dan was to learn his name was “Chi’el’ah”.

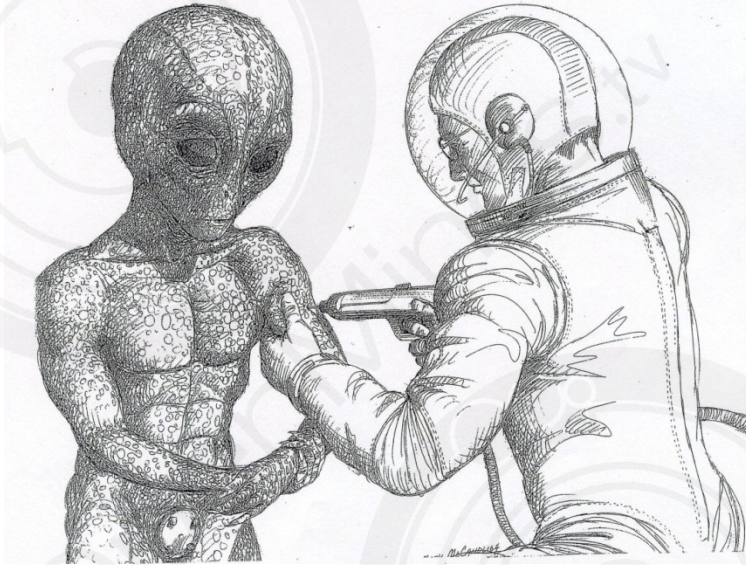

When the “OK” was granted, Dan utilized the Pressurized Induction Needle System (PINS) device to extract 200-300 tissue samples from the J-Rod between 1994 and 1996. These samples were volunteered by the J-Rod.*



Color illustration depicting Dr. Dan Burisch taking a tissue sample from the J-Rod in the Clean Sphere.*

As their relationship developed, the J-Rod allowed Dan to see a mental picture of his family and explained many details from his home world. He explained that he was very old, and that his species survives on a mostly liquid diet, augmented by nutritional pastes. The officially sanctioned name given to the visitor was EBE-53AZ2. EBE stands for Extraterrestrial Biological Entity. EBE-53AZ1 was a P-45K J-Rod that was sent to the Los Alamos National Laboratory YY-II containment area. The P+45K J-Rod, taken to Los Alamos, was brought into a containment facility, codenamed for him as “ICE.” The codename was attributed to the 15 crystalline phases of water, as a meaningful reason to the numerological J-Rods to accept the “name” of the facility in which he was stored – the name “J-Rod” itself having the same meaning: 15. The usage of a “water” term (ice) was especially meaningful given the naming of the new project – Aquarius – being the “water bearer”.

Concerning the leaked official facility designation of YY-II-

The facility was really named (with official designations) after the 1953 arrival of the P+45K J-Rod that Bill Uhouse worked with, as “Y11” NOT YY-II. The last portion of the coded facility designation, meaning the –II, actually was an 11 (eleven) for “Project Aquarius” as Aquarius is the eleventh zodiacal sign. The Y stood as a reference for the Mayan “Yaluk” as the P+45K J-Rod referred to the P+24K Roswell crash victims as such, due to their mishap from atmospheric electrical discharges. The Y being the 25th letter of the English alphabet, being added to the two 1’s, was $25+2 = 27 = 2+7 = 9$. He was the J-Rod that Bill Uhouse met. EBE-53AZ3 died on impact at the Kingman AZ crash site.

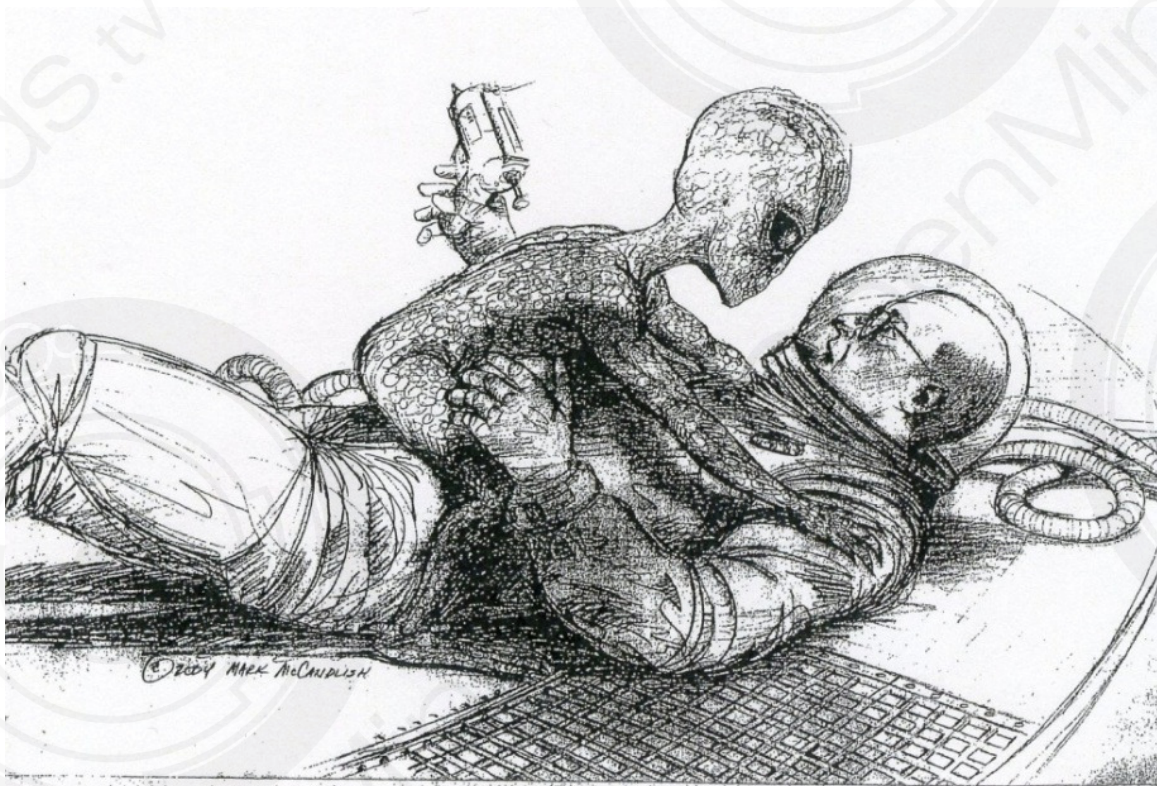

Sketch depicting Dr. Dan Burisch and the J-Rod in the Clean Sphere.*



Color depiction of Dr. Dan Burisch and the J-Rod in the Clean Sphere.* (Note: grid structure on CS floor actually extends across the entire floor in one direction)

A massive download of information from the J-Rod to Dan occurred one day when the J-Rod chose to break the established protocols of greeting. After Dan entered the clean sphere, and conducted the established entry protocol of raising his right hand in friendship, Dan began to step toward the J-Rod. This procedure consisted of a slow bride's step-like walk across the clean sphere toward the J-Rod. After Dan took the first step forward and had both feet resting in a parallel position, the J-Rod quickly stood up into a semi-standing position and took a step toward Dan. At that moment, since the J-Rod was not directly communicating with Dan, the J-Rod was only believed to be violating the protocol (that required him to remain in one position) for some "unknown reason". Thinking that the J-Rod would likely remain where he was then standing, Dan moved forward with his second "bride's step". At the conclusion of Dan's second step forward, the J-Rod quickly stepped forward again.

In a panic, no matter how close he felt to the J-ROD at that moment, and as the J-Rod then began to entrain Dan with telepathic activity, Dan began to stagger forward for a moment. This increased his panic due to the J-Rod's unusual behavior. Dan then lunged backward catching the heel of one of his boots on the grating of the clean sphere floor, and fell backward onto his back. Due to the nature of the environmental suit Dan was wearing, it was difficult to move let alone get up after falling to his back. As Dan tried to raise himself from the floor, the J-Rod quickly approached Dan and climbed onto Dan's torso. The J-Rod was positioned on his knees while on Dan's torso with his hands forward leaning on Dan's helmet-locking mechanism just below the front of Dan's chin. When the J-Rod fell forward with his hands on the locking mechanism, he did so with clenched fists, which sounded like a loud bang from Dan's perspective. Dan's eyes widened but he said nothing, and did very little because he knew that one aggressive strike by him onto the extraterrestrial, given the fragile nature of the J-Rod's body, would have easily killed the being. The radio system erupted with calls to rapidly change the internal pressure of the clean sphere in order to inflict pain on the J-Rod to incapacitate him. During that same moment, the J-Rod began to heavily entrain Dan, causing Dan to begin the relaxation process. This process is almost identical to that used by P-45K J-Rods during human abductions.

Dan tried to inform his coworkers via the radio system that he was not being attacked or harmed by the J-Rod, as they feared was occurring. The J-Rod proceeded to “download” a series of incredible visual images into his mind. This important information corroborated that the J-Rod originated from our own future, as well as having travelled to our distant past. The J-Rod also revealed to Dan that in the J-Rod’s distance past there had been a significant catastrophe. That catastrophe, by its position in the J-Rod’s past, was to then (1994) occur in our reasonably near future. The nature of the catastrophe was to have been a massive geophysical pole-shift of slightly less than 5 degrees which resulted in the death of over two thirds of the human species as well as the extinction of many of the world’s species. The precise cause of their catastrophe was to have been the reaction of the asthenosphere to a massive explosion of energy from our sun. The crust on many areas of our Earth was said to have shifted by virtue of this energy from the sun striking Earth. Promoting their catastrophe were devices that had been built, and were in operation at various locations around the Earth at the time of the solar bursts. Those devices were determined to be the very Einstein-Rosen Bridge accessing devices (Stargates) and Looking-Glass mechanisms currently being used in 1994.

Since the time of this revelatory material being learned by the governments of Earth, all such devices have been decommissioned. The result of their catastrophe was to have ultimately been a serious genetic split in the human species-ultimately producing the J-Rods and Orions. Many thousands of years after their catastrophe the ones to be called Orions departed this Earth for bases first on the moon, then on Mars, leaving traces of their colonization as they went. Many thousands of years after the Orions departed from Mars to their ultimate home in the Orion constellation, the J-Rods departed from Earth directly to their future home in Zeta Reticuli. In the mean time, prior to the J-Rod’s leaving from Earth to Zeta Reticuli, they once again used time travel, a process close to the means that originally caused their own catastrophe, to jump back in time from a period roughly correlating to 24 thousand years from now to July 1947. As we all know from the Roswell incident, their trip was not very successful. Aside from much information the public knows, what it generally does not know is that day, in the clean sphere, when the J-Rod stepped upon Dan to impart information to him, the J-Rod downloaded about 300 diary volumes of material of the 400+ diary volumes that Dan has written since his induction into Majestic in 1986. Fully three fourth’s of the diary writings came from approximately ½ hour constant download, from the J-Rod that day in 1994.

Dr. Marci continues to refuse requests for direct access to Dan’s diary material, due to the very concerns being outlined for continued disclosure to the population of the world by the “secret government”. The material spans everything from the corrected histories since antiquity, to the possibilities of future events of the time-line in which humanity seems travelling. The one best note that Drs. Dan and Marci seem willing to release is that the afore mentioned major catastrophe, and even a major but lesser “follow-on” catastrophe has been averted due to the positive actions of human kind during this time in history. Our positive consciousness during this time in the face of individuals and groups who have attempted to drag humanity into every possible manner of destructive thought has and will fail. As a matter of the facts concerning his personal arrival: It was determined that the J-Rod was recovered from the UFO that crashed north-west of Kingman AZ on May 20th, 1953. As Dan would learn, a purpose of the J-Rod coming to earth in our time, was an attempt to find a cure for the neuropathy through perhaps gene hybridization to cure the disease in his time (our future time). Aside from the J-Rod’s political orders, he was to seek this bio-medical assistance because it was believed that the intact genome of present-day humanity contained something more than “the Orion and J-Rod” sum of its parts: something the J-Rod and other Orions referred to as “the joined resonance”. Some Orions referred to it as the “conjoined resonance”. This is the dark secret as to why the earlier P-45K J-Rods have been so aggressive in the sampling of humanity (human abductions) prior to the time in which we live.

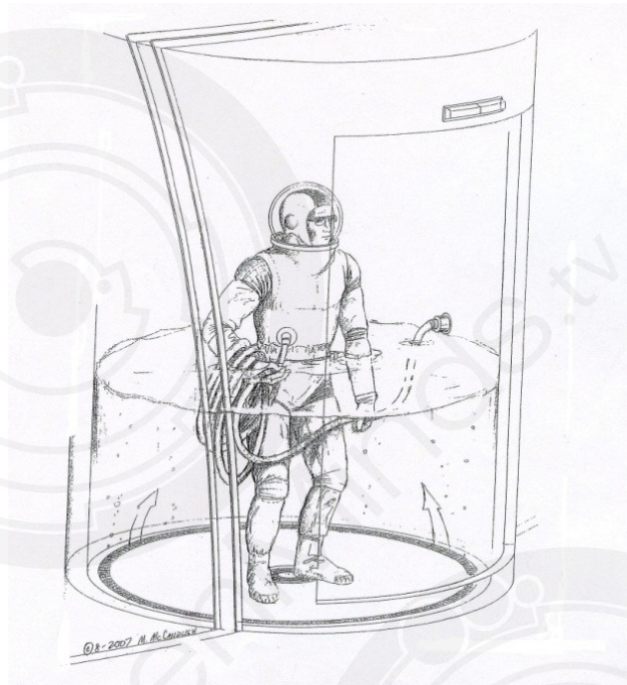

Sketch depicting the decontamination process.*

After each assignment within the clean sphere was completed, both Dan and the J-Rod had to undergo a decontamination process. The J-Rod was decontaminated by a little known team, part of which remained in 24/7 personal residence within the Ambassadorial Suite Level (ASL), which was the location the clean sphere was lifted up from, prior to it being locked in place on the Level 4-5 floor for interaction with AQJR2. Another part of that quiet team who dealt directly with the J-Rod in the ASL was called “The Wise-men”. That group was periodically seen on all floors of S-4, and on occasion even dined near other workers in the “Nevada Room” on floor 1. Other information about them is available, but not pertinent to this report. The decontamination procedure for Dan was specifically designed to sterilize the TES to eliminate any potentially harmful microbes or other materials.

What eventually became of the J-Rod that Dan had contact with at Area S-4? According to Drs. Dan and Marci as well as many other theorists and investigators, there are a number of naturally occurring worm-holes or “Stargates” (temporarily if not specifically) located around Earth. One location being Iraq, and another location near the Abydos Temple, along the Nile River in Egypt. Per Dan’s comments, the Sumerian culture (6,000 years ago), figured out how to access these worm-holes, and preserved the “blueprints” regarding this process on “cylinder seals”. Thousands of these seals were at one time stored at the Bagdad Museum in Iraq (now called the National Museum of Iraq). According to Dan, a group of scientists used information they found on the cylinder seals to engineer a Stargate device. This was done by a process of “mirror imaging” many of the cylinder seal depictions. (Dan has a large collection of design aspects for Looking Glass, Stargate, transport pad, and flying disc engineering schematics-all revealed by the mirror-imaging process).

The Stargate device could access naturally occurring worm holes, and “piggy back” on them to transport information, and even biological material (in very limited circumstances) vast distances across the universe. At this point, we need to discriminate between the Looking Glass device, Einstein-Rosen bridge accessing devices (Stargates, EBADS), and the power plants used by disc-like craft to travel vast linear time distances and even “time travel”. The Looking Glass device on Floor 2 of S-4 was not capable of transmitting any material from here to anywhere/when else. It’s time travel capabilities were restricted to information coming into our present time from another time location. In that sense, it functioned like the Orion Cube, but human interaction with the

Looking Glass could not affect data from the Looking Glass. The Looking Glass was back engineered, originally from the Stargate devices by removing two components from the Stargate devices, and by changing the angle upon which the central device was positioned with respect to the center of the Earth. The Stargate device as originally engineered from the secrets in the cylinder seals was capable of sustaining a “strange matter” field for a limited period of time, before the field would collapse.

The power plants that the flying discs and planforms used, which were housed at S-4, produce a space-time distortion of the kind generally explained by the previous testimony of Robert Lazar. The power plants however lacked the engineering structure to enable distant forward/backward dialing; save that of the power plant which had been originally placed in the Roswell craft. The majority of the disc-like craft at S-4 were only capable of promoting instantaneous point to point transit. Slight changes in the P-52K J-Rod and Orion power plants would enable those craft to acquire the same configuration as their distant predecessor craft; the “Roswell” terrestrial time plan-form. The acquisition of the cylinder seals and Stargate technology may be one reason why during the invasion of Iraq in 2003, one of the first places that U.S. troops were told to enter was the Bagdad Museum. This was clearly an effort by members of the elite to recover the technology associated with accessing these Stargates for personal gain. (see the exopolitical discussion by Dr. Michael Salla about Iraq and Stargates)

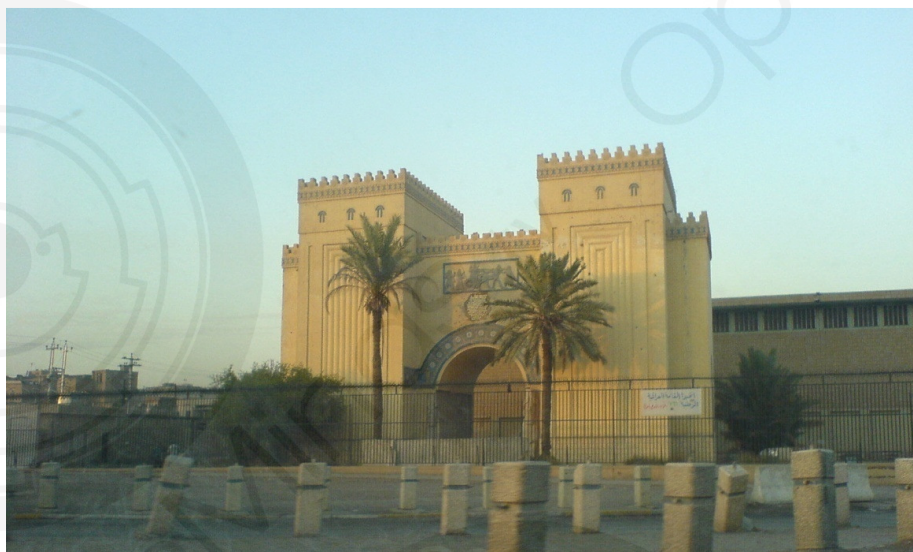

Bagdad Museum in Iraq (now called the National Museum of Iraq)

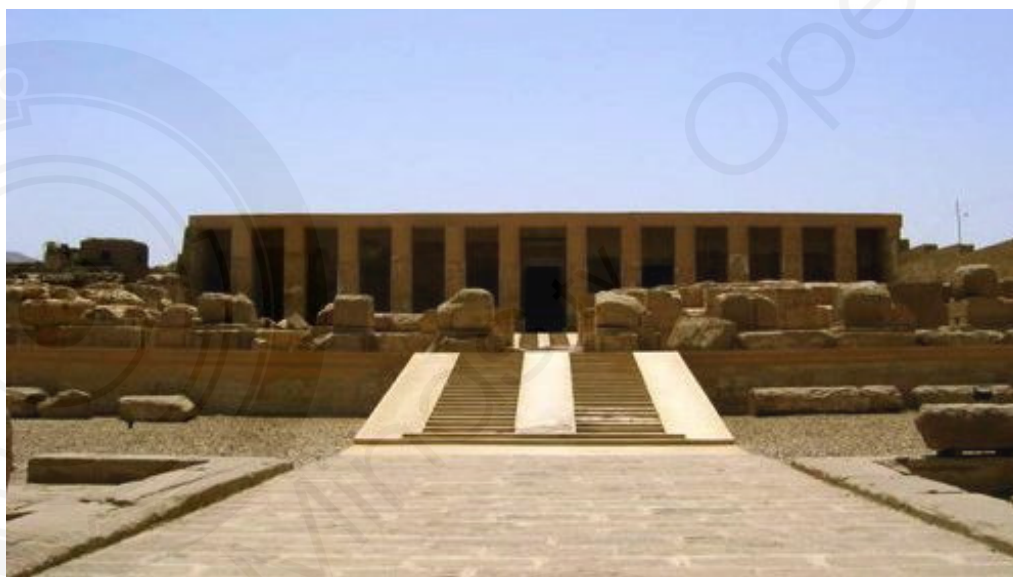

Abydos Temple along the Nile River

STROLLER

DESIGNED BY THE "WISEMEN" IN CONFERENCE WITH THE J-ROD FOR HIS COMFORT, AND TO SECURE ENVIRONMENTAL CONTROLS

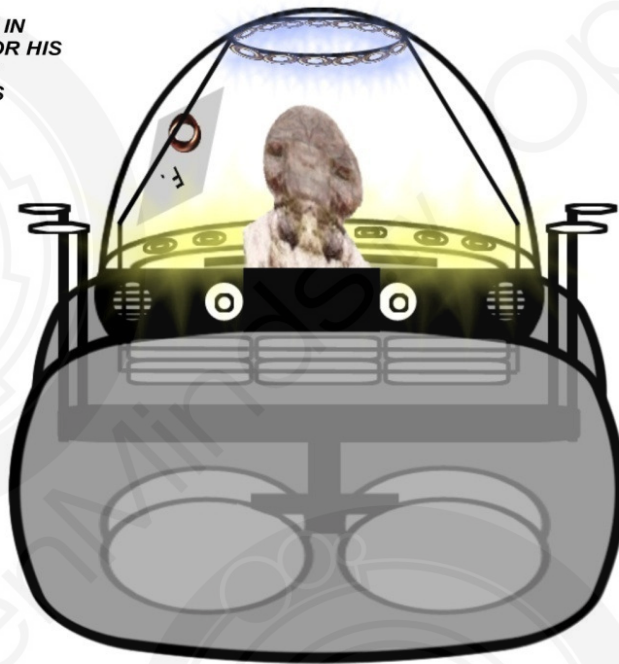

Details of stroller configuration above per Dan Burisch

“Stroller” used during transportation when Chi’el’ah was removed from the clean sphere. This device consisted of a clear transparent elliptical “egg shaped” chamber which could maintain the same pressurized atmosphere found at level 4-5 of Area S4.

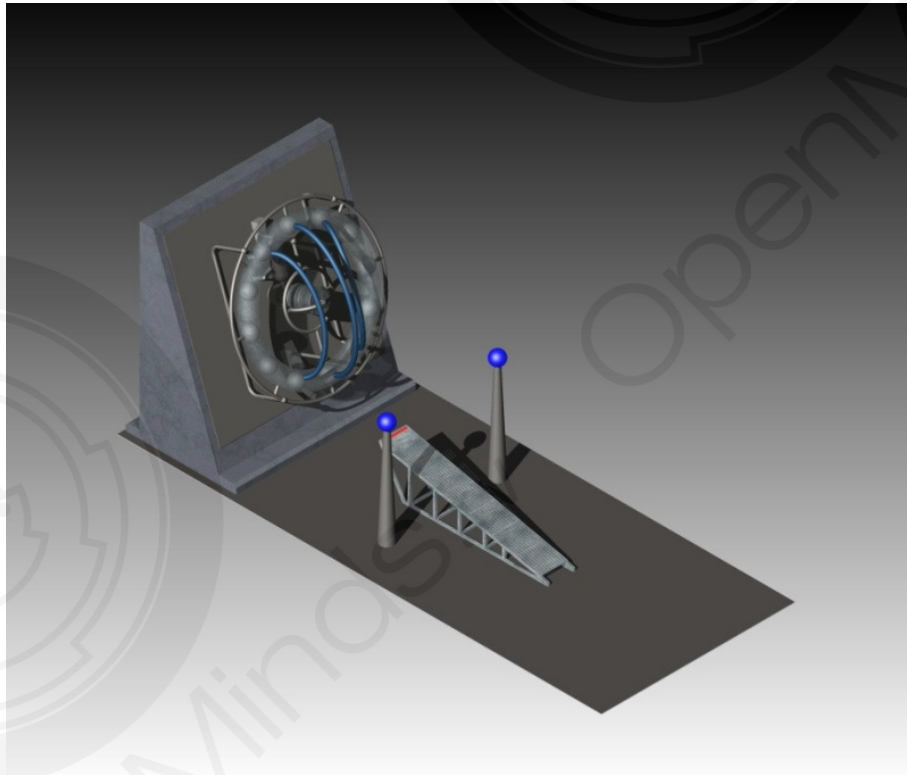

Illustration of ramp leading up to the Stargate device during incident at Abydos.* (Note: J-Rod’s “stroller” is not shown in this illustration).

In 2003, J-Rod was moved from his position inside the clean sphere, and transported thousands of miles away to a location known as the Abydos Temple along the Nile (see map above). Dan attended this meeting which also included a number of high level military Brass because a wormhole had been localized and plans had been made to use it with the Stargate device in an effort to allow the J-Rod to communicate with his political structure. Prior to the J-Rod engaging in conversation with his political structure, and as that political structure was located on his home world in Reticulum, the J-Rod pleaded to Dan to violate protocol, thereby risking the J-Rod's life, but giving him a chance to return to his home. Dan violated protocol (also at risk of his own life) and engaged the stroller forward into the open ERB field.

The stroller containing the J-Rod entered the field and tumbled forward. Due to the speed of the stroller and Dan's forward momentum (at its back left corner) he too stumbled forward and fell into the ERB field. He along with the physical stroller mechanism, was violently expelled from the ERB field. Neither he nor Dr. Marci, have been provided with a complete explanation of how and why this occurred. Being a biologist and Musicologist respectively, neither would be speaking "in school" should they venture an explanation of the physics involved. While the J-Rod is believed to have returned to his home world and time, his whereabouts officially remain unknown. Dr. Dan is in further possession of possession of information concerning the circumstances of the J-Rod, however he is very reticent to describe much about the occasion in 2003. The disclosures made by Dr. Dan Burisch should not go unnoticed, and this brave man should be honored in helping mankind realize their place in the universe.



A final bit of nostalgia provided by Dr. Dan Burisch included specific details regarding a sign that had been placed near the end of one of the runways at Groom Lake. The sign (believed to have dated back to the 1970's), was faded from constant exposure to the harsh sun. It consisted of multiple arrows pointing in different directions. This appeared to be a symbolic reference that "home" for some of the inhabitants of Area 51/S-4 was both underground and perhaps outer space.

“I have never met an alien, but I have met an extraterrestrial”....Dan Burisch, Sc. D.

The difference being that such an extraterrestrial such as a J-Rod is actually a future human, and therefore shares a similar human lineage.

A true alien on the other hand, would bear no such direct human lineage.

Copyright 2010 by OpenMinds Production, LLC. All rights reserved. Reproduction in whole or in part without permission is prohibited. OpenMinds is a registered trademark of OpenMinds Production, LLC.

The opinions and views expressed in this article do not necessarily reflect those of Open Minds Production, LLC.

Additional comments/feedback are welcome, and requests may directed to Michael Schratt at the email address below:

michael@openminds.tv